STAR CONTROL II

1

Table of Contents	
Introduction	5
Starting the Game	25
Confirm System Requirements	25
Installing Star Control II	25
Start-up	26
Play Controls	27
Menu Controls	27
Keyboard Menu Controls	27
Joystick Menu Controls	28
Combat Commands	28
Default Keyboard Combat Controls	28
Joystick Combat Controls	29
Navigation	29
The Effects of Inertia and Gravity	29
Interplanetary Travel	30
Encounters in Interplanetary Space	31
Entering Planetary Orbit	31
Planet Types and Descriptions	31
“Pushing” Up into HyperSpace	33
HyperSpace Travel	34
Fuel Use in HyperSpace	34
Encounters in HyperSpace	35
Returning to TrueSpace	35
Ship Commands	35
Starmap	35
Alien Spheres of Influence	36
Using the Autopilot Feature	36
Scanning a Planet	37
Specific Scans	39
Mineral Scan	39

STARCONTROLL II

2

Biological Scan	40
Energy Scan	40
Dispatching a Lander	40
Planet Surface Exploration	41
Lander Status Display	41
Returning to the Flagship	41
Gathering Minerals	41
Planetary Hazards	42
Collecting Life-form Data	43
Flagship's Manifest	43
Checking Cargo	43
Using Devices	44
Ship's Roster	44
Game Options	45
Saving a Game in Progress	45
Loading a Saved Game	45
Changing Game Settings	46
Changing Names	47
Quitting the Game	47
The Earth Starbase	47
The Starbase Commander	48
Transferring Minerals to the Starbase	48
Outfitting Your Flagship	48
Flagship Characteristics	49
Fuel	49
Flagship Enhancement Modules	49
Adding and Removing Modules	50
The Shipyard	51
Adding and Removing Crew	51
Combat Vessels	52
Leaving the Starbase	53

STAR CONTROL II

3

Encountering Alien Races	54
Combat Sequence	54
Conversing with Aliens	55
Attacking Aliens	56
Combat	56
Selecting a Ship	56
The Battlefield	56
Navigating Your Ship in Combat	57
Collision with Asteroids and Planets	57
Ship Status Displays	57
Crew	57
Batteries	58
The Basics of Blasting	58
Victory and Defeat	59
Running Away	59
Analyzing Enemy Wreckage	60
Appendix I: Known Alien Races	61
Races in the Alliance of Free Stars	61
Races in the Ur-Quan Hierarchy	65
Appendix II: Play Tips for Star Control II	70
Maximizing Available Memory	70
Enhancing Game Performance	70
Solving Possible Conflicts with TSRs	71
Known Conflicts	71
Specifying Sound Card on the Command Line	71
Loading Problems	72
Garbled Graphics or Blank Screen	73
Graphic Adapter Fix	73
Booting Clean	73
Technical Support	76
Online Support	76

STAR CONTROLL II

4

Appendix III: Instructions for SuperMelee	77
Starting SuperMelee	77
The SuperMelee Main Screen	78
Creating a SuperMelee Team	78
Game Settings	79
Who Controls Each Team	80
Input Device	80
Computer Opponent's Skill Level	80
Leaving Settings Menu	81
Saving and Loading SuperMelee Teams	81
Fighting in Melee	81
Picking Ships	81
Fighting a Battle	82
Winning SuperMelee	82
Replaying Melee with the Same Teams	82
Returning to the Team Edit Screen	82
Appendix IV: Keyboard Configuration Utility	83
Appendix V: Combat Vessel Descriptions	83
Appendix VI: Flagship Modules	98
Game Credits	101
Legal Mumbo Jumbo	102

INTRODUCTION

Welcome aboard. **Star Control II** will take you on a far journey, a space odyssey encompassing the realms of science-fiction and role-playing. This epic adventure spans hundreds of light years, and evokes a history reaching back over 250,000 years. As you travel out among the stars, your decisions and actions will directly affect the destiny of 18 intelligent, star-faring species, including the inhabitants of Earth. **Star Control II** is only in part a sequel to *Star Control*, which focused exclusively on the strategy and tactics of the bitter Ur-Quan Slave War (known by the philosophical as the Great Crucible of Sentience). You need not have played the first game to enjoy this one. However, if you have never fought a *Star Control* space-battle, you may wish to practice with the *SuperMelee* game before facing enemy forces. The evil aliens you will encounter are adept at the art of war, and unforgiving of weakness. The history that follows details the critical involvement of Earth in the conflict between the Alliance of Free Stars and the villainous Ur-Quan Hierarchy. Study what happened, learn from the mistakes of those that went before. Only in this way will you be prepared for the mystery, the intrigue and the blazing action of **Star Control II**.

In the Beginning

The time is in the year 2155. Yet the story begins over two centuries before, in the 1930's, a time when surface vehicles on Earth burned fossil fuels. It's all hard to imagine now, of course, getting from place to place in a dangerous noisy machine with an engine that set fire to spurts of prehistoric goo. Makes one shudder. Humans had another quaint oddity in those days; it was a little box called a radio that transmitted a mindless mix of music and speech. The radio was a harmless diversion, really, until the radio towers got taller and the broadcasts got stronger. Until the transmissions began to pulse out into the vacuum of space, riding electromagnetic waves throughout the universe. It wasn't long before the broadcasts from Earth reached distant stars, and several alien races took notice of this new evidence of life on the far-off blue planet. One of the species listening was the Ur-Quan, a life-form devoid of conscience or character, a race genetically compelled to conquest. As early as 1940, the Ur-Quan began to formulate sinister schemes to attack Earth. Other aliens, meanwhile, benign species that wished only peace, lay plans to warn Earthlings of the Ur-Quan threat.

The Scrutiny of Earth Intensifies

From their strange worlds many light years away, both good and evil aliens watched with growing interest as Soviet Cosmonaut Yuri Gagarin became the first human to orbit the planet in 1961. Less than a decade later, a tremor swept through the advanced life-forms beyond the solar system as American Astronauts Armstrong and Aldrin became the first men to tread Earth's satellite moon.

Alien scrutiny of Earth intensified. Meanwhile, the fratricidal conflicts that had scourged mankind since the species evolved continued unabated. The Small War of 2015 came close to obliterating civilization on Earth when

STAR CONTROLL II

7

nuclear combat broke out between several Middle Eastern countries. Fortunately the exchange was relatively small, limited to less than a dozen warheads, and a global conflagration was narrowly avoided. Even so, nearly a million people died. The terrible loss of life and the near-thing of a planet-wide Armageddon sobered heads of government around the world. The leaders of the industrialized nations and the Third World met at the United Nations headquarters in New York and agreed to cooperate in an immediate strengthening of U.N. authority. Within six months, the U.N. Security Council had assembled a large Peace-Keeping Army and assumed worldwide control over all weapons of mass destruction. “Mass-kill” devices were gathered up from every country that possessed them. The weapons were then dismantled and their components stored in huge subterranean bunkers that came to be known as “Peace Vaults.” Simultaneously, the U.N. outlawed the sale of smaller arms. It took nearly a decade to end all armed conflict on earth. Yet the goal was finally achieved. Ten years after the U.N. summit, in 2025, the Earth experienced its first year without war.

To ensure the total destruction of the arms trade, the United Nations prohibited future weapons research, including the development of nuclear fusion and fission technologies that might be adapted for bomb-making purposes. Laser applications were also closely monitored to prevent the design of “Star Wars” like weapons.

Despite these restrictions, science continued to advance across a wide spectrum of disciplines, especially in bio-technology. Brilliant Swiss Scientist Hsien Ho combined the now-complete human genome map with sophisticated genetic-engineering techniques and perfected the artificial parthenogenesis – cloning – of humans at the Zurich BioTeknik in 2019. Though the clones were, to all external appearances, human, Hsien Ho modified their genes so that they were not capable



of producing offspring.

Meanwhile, a new religious order, known as Homo Deus, or “The Godly Men,” was founded in the aftermath of the Small War and the emotional turmoil caused by the destruction of the Holy Lands. Its charismatic founder, former car salesman Jason MacBride, built his worldwide following on the thesis that the Millennium was near. MacBride even predicted a specific date, March 11, 2046, when Heaven and Earth would join, and each devout person would be elevated to a divine status. The movement captured the imagination of millions of poor and disillusioned individuals worldwide. Within a few years, “Brother Jason” was one of the most powerful and influential people on the planet.

For most people on Earth, the following two decades were a golden time of peace and prosperity. This was not the case for Hsien Ho’s now adult clones. Seeing Ho’s creations as a threat to his “Godly Men,” Jason MacBride fought to have the clones declared sub-human. Calling them “Androsynths,” or the “fake men,” he used the vast resources of his Homo Deus organization to strip the clones of their human rights. Sadly, as the years passed, the Androsynths became little better than well-treated slaves.

Not unexpectedly, March 11, 2046 came and went without the arrival of Jason MacBride’s promised Millennium. Citing a “lack of genuinely devout people,” MacBride withdrew from public life and faded into obscurity, his power and fortunes rapidly declining.

By the middle of the 21st Century, Earthlings had begun to colonize their solar system. Planet orbiting factories led to lunar bases and soon there were mining and research outposts scattered across the Asteroid Belt. Yet the expansion of mankind into deep space was limited by the relatively slow speed at which spacecraft could travel. Research began in earnest to develop a ship that could warp toward distant stars faster than the speed of light.

The Androsynth Rebellion

In retrospect, the Clone Revolt of 2085 was inevitable. Stronger, smarter and more adaptable than normal humans, the Androsynths despised and deeply resented their status as slaves. By the late '70's there were tens of thousands of Androsynths distributed across the planet, many of them doing sophisticated scientific and technological research. Then, in the spring of 2085, the Androsynths staged a worldwide rebellion, throwing off their chains with the help of a sympathetic human underground.

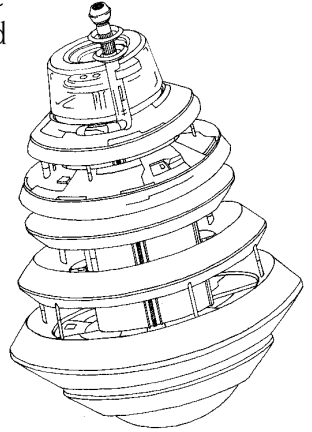

The uprising had been exquisitely planned. Within 24 hours, the clones had captured nearly every space-flight facility on the planet. Androsynths working at the centers had secretly fueled and readied over a thousand spacecraft to carry their people off this hated planet. Two days after the rebellion began, the freed clones took over all orbital and lunar bases, leaving not a single Androsynth on the face of the earth. "Star Control," the recently established wing of the United Nations' military forces, made several attempts to evict the clones. Each time the Star Control ships approached, the craft were burnt to ashes by colossal MASER weapons that Androsynth scientists had fashioned out of formerly benign energy broadcast units.

After two months of futile strikes on the Androsynth strongholds with conventional weapons, the U.N. leadership decided to use the means of mass destruction stored in the Peace Vaults. Yet before the nuclear bombs and laser rays could be reassembled, Star Control scoutships watching the orbiting bases reported an amazing sight. Eight of the largest space stations were accelerating out of Earth orbit, heading towards the periphery of the solar sys-

tem. The Androsynths had somehow modified the huge space-stations for flight, including the recently finished StarLight Hilton.

Though Star Control chase ships were never able to catch the space-stations, a ten thruster ore freighter on its way home from an Asteroid Belt mining base with a hold full of titanium was able to make a high-V interception of the rag-tag fleet. As the freighter pilot approached the fleeing space-stations, they suddenly began to glow with a bright energy field that spun around the ships with blazing speed. According to the pilot's recorded testimony, a "great red hole" over 500 meters across appeared in front of the space-stations. As he watched in disbelief, the stations flew into the hole one by one and vanished in a starburst of white lights. When the last of the Androsynth strongholds had disappeared, the hole collapsed rapidly inward, imploding finally to nothingness.

Over 30 years would pass before humans encountered the Androsynths again.

Aliens Contact Earth

In 2112, the largest and most remote space installation, Ceres Base, was built on the 700 kilometer-wide asteroid of the same name. Three years later, Ceres Base would be the site of mankind's first official contact with an alien life-form – the crystalline Chenjesu. The alien vessel suddenly appeared out of nowhere, a scarlet flash of light announcing its presence as it took up a position 3 kilometers above the asteroid. Almost immediately, the alien ship began broadcasting this message:

People from Earth: We are the Chenjesu. We mean you no harm. We come in peace with an urgent message. Heed these words: there is a horde of conquering warriors advancing toward your solar system from deep space. They

are called the Ur-Quan. They know you are here. They will make slaves of you as they have made slaves of a thousand races across the galaxy. They will enslave both our species, Chenjesu and Human, unless we stop them now.

We are not alone in our struggle. There are others who will fight with us against the Ur-Quan. Together – in an alliance with the remaining free stars – we may yet turn back the enemy, defeating the Ur-Quan and its Hierarchy of Battle Thralls.

We beseech you to join us, for we desperately need your help. But we do not have much time. What is your answer?

For over a week, the answer from Earth was stunned silence.

The Alliance of Free Stars

The Chenjesu representatives were patient. Beings of vast intellect and perception, they understood the psychological shock their sudden appearance had on the inhabitants of Earth, a people who, amazingly, had never before had contact with a species other than their own. The aliens remained in the solar system for several months, conferring with the political, military and scientific leaders of Earth. Meanwhile, the Chenjesu's starship transported U.N. observers through HyperSpace to visit several worlds that had been attacked by the Ur-Quan and their Hierarchy of Battle Thralls. The sad evidence of wholesale slaughter and devastation, and the accounts of dazed survivors, proved that the Chenjesu account was true. On August 1, 2116, Earth joined the Chenjesu and their other allies – the Mmrrnmhrm, the Yehat, the Shofixti, and unofficially, the Syreen – to form The Alliance of Free Stars.

Following formal ratification of the pact by the United Nations, Star Control

was placed under the direct authority of the Alliance Command Council. The Chenjesu expected Earth to play a major role in the Alliance, both as combatants and suppliers of war material. Even though Earthlings were technologically primitive, their civilization had thousands of huge modern factories and millions of skilled workers able to manufacture both munitions and spacecraft. The tens of thousands of thermonuclear weapon components stashed away in the Peace Vaults were an additional bonus which surprised even the Chenjesu.

On the day following Earth's formal induction into the Alliance, an alien race known as the Ariloulaleelay appeared, landing first on the Earth's moon. They transmitted a request to meet with Alliance representatives, and a delegation of human and Chenjesu diplomats journeyed to the lunar surface to establish contact. The Arilou explained that they too were threatened by the Ur-Quan and had come to join the Alliance of Free Stars. Alliance headquarters was consulted, and soon afterwards the Arilous were welcomed into the coalition. Although the Arilou were extremely secretive – being unwilling to discuss even the locations of their homeworlds – they provided additional strength to the Alliance. This strength was to be tested almost immediately.

The Course of the War

There were many great battles between the Alliance of Free Stars and the Ur-Quan and their Hierarchy of Battle Thralls. Both the Alliance and the Hierarchy built hundreds of asteroid forts all across the spiral arm of the Galaxy. Only a small fraction of these fortified positions, and the colonies and mining bases that surrounded them, survived the fighting.

As the war spread, new alien races were drawn into the conflict until finally there were 14 separate species at war. On the Alliance side there were the Earthlings, the Chenjesu, the Yehat, the Mmrmhmr, the Ariloulaleelay, the Syreen, and the Shofixti. Fighting with the Ur-Quan were the Mycon, the

Spathi, the Androsynths, the VUX, the Ilwrath, and the Umgah.

By 2134 it was becoming clear to both sides that the Ur-Quan and their Hierarchy of Battle Thralls were slowly but surely winning the war.

Captain Burton's Discovery

On March 16, 2134, Star Control Captain I. Burton, a highly respected 28-year old female Earthling, was leading a task force of heavy cruisers on a deep recon into what was believed to be a friendly sector near the Zeeman-Vela star cluster. Burton was brilliant and beautiful, with wide-set deep blue eyes, a white even-toothed smile and silky straw-colored hair. She also had a figure that turned heads, even aboard a warship hurtling through deep space. She had just taken a navigational star fix when the ships from Earth were suddenly ambushed by an elite force of Androsynth Guardian combat vessels. The Androsynth ships had been modified for

extended blazer mode, giving them increased speed and range. The task force was cut to shreds and only Burton's vessel, the Tobermoon, escaped immediate destruction.

Knowing the Tobermoon could not outrun the Guardian ships, Captain Burton engaged in a desperate ploy to save the ship and crew. Fear crinkling the corners of her deep blue eyes, she warped her craft toward the heart of Zeeman's Star, a nearby supergiant sun. She had a desperate plan, a last ditch ploy she prayed would confuse the pursuers' sensors. The bridge crew began to panic as heat in the cabin climbed to oven-like temperatures. Two enlisted men finally broke under the pressure and came for Burton, terror in their eyes and sweat pouring down their faces. But the captain had guts as well as beauty. She drew her sidearm and held the mutineers off, gaining the precious minutes she needed. Finally, the cabin temperature now nearing 150 degrees Fahrenheit, she judged they were close enough to the titanic star for her plan to work. As the Tobermoon's outer hull

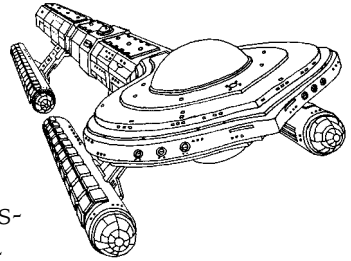

began to liquify, Burton jettisoned the ship's entire stock of nuclear missiles and detonated them. From the Androsynths' perspective, the vessel they were chasing had exploded when it flew too close to the superhot sun.

As the Androsynth task force warped out of the system, a severely damaged Tobermoon slowly emerged from its hiding place behind Zeeman's Star. Burton ordered a damage report. As she'd suspected, the craft sustained severe damage. Worse, the ship's engineers informed her they couldn't make repairs without a planetfall on a world with a breathable atmosphere. Like most supergiant stars, Zeeman did not have any Earth-like planets in orbit around it. The Tobermoon limped through space for almost a week before Hyper-Radar reconnaissance located a hospitable planet orbiting the dwarf star Vela. The planet was called Vela II, and it proved to have both an oxygen rich atmosphere and deposits of metal ore the humans could refine and use to repair their ship.

After a successful landing, Burton ordered the engineers to begin repairs. She sent the rest of the crew off to explore their surroundings. It was only pure chance that a young ensign chose to enter an unremarkable cave in a nearby hillside. What he found within the cave was the most remarkable discovery of the century – a huge underground installation, the size of a small city, built in the distant past by an extinct race known only as the Precursors. The cave was massive, over 2500 meters long and averaging 50 meters from floor to ceiling. Off the main tunnel were countless side passages and hidden niches, almost all crammed with futuristic equipment and hundreds of long-dormant robots. Halfway down the main gallery, a deep crevasse sliced across the tunnel floor, evidence of a tremendous prehistoric earthquake that had offset the adjoining walls by more than ten meters. Over the centuries, water trickling into the cave from the planet's surface had carried countless minute traces of calcium carbonate that settled out as lime. As the limestone sediment built up, the deposits covered much of the Precursors' wondrous machinery with a smooth

coating called flowstone that was now five to ten meters thick in places. Artifacts of this powerful and technologically advanced alien species had been found in every quarter of known space. Yet this was the first time an entire Precursor base had been discovered. Captain Burton recognized that the wealth of advanced technology could bring the Alliance victory over the Ur-Quan – but only if scientists could be brought to Vela II to study the fantastic find.

Realizing that the surrounding region of space could fall under the control of the enemy at any time, Burton accelerated repairs to the Tobermoon and rocketed back to Earth at emergency warp speed to report her findings to her superiors at Star Control. Within a week, the Tobermoon was on the return leg to Vela II, crammed full of hastily assembled scientific equipment and experts on both the Precursor's civilization and their advanced xenotechnology.

Expedition to Vela II

The most respected but least liked Precursor expert in the expedition to Vela II was Professor Jules Farnsworth. The professor was well known for his formidable intellect and his extensive knowledge of the Precursor civilization. Though recognized as a great mind, Farnsworth was also widely disliked for his flamboyant egotism and rude impatience with peers who did not hang on his every word. The man was simply impossible to work with for anyone with a modicum of self-respect.

It wasn't long before both his fellow scientists on the mission and Captain Burton rued the decision to bring Farnsworth along, for the professor did little but complain during the voyage from Earth to Vela II. Yet, as irksome as he was, Professor Farnsworth proved his worth almost immediately upon his arrival at the Precursor installation. Within hours he located the base's deactivated central control computer. While the professor worked feverishly on the ancient aliens' computer, Captain Burton received a fateful message from the

Star Control High Command.

As feared, the Ur-Quan had smashed through the defensive lines drawn between the Mira and Indi constellations. Star Control reconnaissance ships reported that a large Hierarchy task force was hurtling toward the Vela star system. Captain Burton was ordered to evacuate all personnel from Vela II and return to Earth immediately. Burton's heart beat like a hammer in her chest as she read the rest of the message. Star Control was paranoid that the Precursor's advanced technology would fall into the hands of the hated Ur-Quan. To prevent the Hierarchy from obtaining these ancient secrets, Burton was ordered to install nuclear devices throughout the Precursor installation. Once the Tobermoon was in orbit, she was to set off the weapons and destroy the entire complex.

The non-military members of the Vela II research team were stunned by the order. Destroy the most significant discovery of the century? It was unthinkable! Professor Farnsworth was especially distraught for he was in the middle of several critical research projects that promised to unlock ancient Precursor technical secrets. In an uncharacteristic display of courage, Farnsworth offered to remain behind, promising to detonate the nuclear bombs if the Ur-Quan found the Precursor caves. The majority of the other scientists and engineers also asked to stay on Vela II and continue their research. Finally, Captain Burton was persuaded that saving the treasure trove of advanced Precursor technology was more important than obeying a direct order from the High Command. Still, she didn't trust Farnsworth to detonate the nuclear bombs should the Ur-Quan land. She decided the only logical thing to do was to remain behind herself.

On August 11, 2134 Captain Burton gave over command of the Tobermoon to First Officer Chi, with orders to

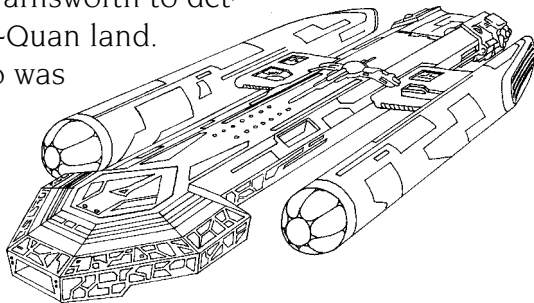

leave the star system immediately. He was to return to Earth at best speed and brief the High Command on the expedition's desperate attempt to save the Precursor installation. Chi promised to return with a relief party and supplies as soon as the Ur-Quan attack was repulsed. After the Tobermoon had lifted-off, the team quickly moved all their equipment deep into the cave system and obscured all signs of their presence from the planet's surface. Now, if an Ur-Quan reconnaissance ship scanned the terrain, Vela II would appear uninhabited. The weeks turned into months as Captain Burton and her team of 200 waited for the return of the Tobermoon.

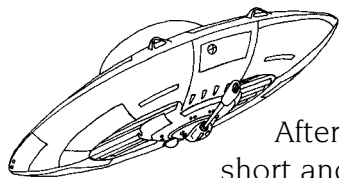

Marooned

After six months in the caves, food reserves grew critically short and Captain Burton imposed strict rationing. Professor

Farnsworth found a data bank in the computer memory describing Vela II's flora and fauna. Burton felt her spirits soar as Farnsworth pointed out several plants and animals that could be harvested for food. The most likely sources of meat were the red-brown Libixx, animals that looked like winged rabbits, and the six-legged Ortogs, 2,000 pound beasts with pendulous udders that resembled a cross between a cow and a lizard. Both had cell structures, internal organs and flesh remarkably similar to mammals on Earth. The Precursor data also indicated that several plant species – especially the giant blue-flowered Iccamullon – had the same proteins, sugars and starches as crops humans had been raising for centuries. Captain Burton assigned teams to hunt wild animals and harvest food plants, allowing them out of the caves only under cover of dark for the first year they were there. Then, gradually as the years passed, the marooned Earthlings grew confident they were safe from discovery by the Ur-Quan on this out-of-the-way little planet. They began to see themselves as colonists and most moved out of the caves to settle on the surface. Still, with Captain Burton prodding them, the humans remained cautious, building camouflaged houses and planting crops in purposefully chaotic patterns. Eventually they gave their planet a name: Unzervalt. It meant, sim-

ply, “our world.”

Ten years slipped past, marked by the deaths of a dozen colonists from accidents or old age, and the birth of 42 children. Several of the scientists had now become full-time farmers. Others fabricated old-fashioned bullet-firing rifles and disappeared into the Unzervalt wilderness, appearing months later clad in Ortog skins and bursting with tales of strange landscapes and even stranger life-forms.

Farnsworth’s Breakthrough

After more than a decade of hard work, Professor Jules Farnsworth announced with considerable fanfare that he had finally succeeded in unlocking the secret of the Precursor Control Computer. Without Captain Burton’s permission – indeed without even knowing what would happen – Farnsworth commanded the computer to initiate its prime function. The resulting near-disaster almost got the professor put in the stockade.

Suddenly, the immobile machinery within the cave roared to life. Huge electrical arcs shot between massive electrodes, incinerating a wooden storage shack. Robotic vehicles began tearing across the cavern floor along pre-programmed paths – paths which led them right through several man-made buildings. A 30 meter tall crane-like machine detached itself from one wall and swiftly rolled through the cave, nearly crushing a group of panicked scientists. It was a miracle that no one was killed in the ensuing chaos as humans fled the caves in terror.

The next day, robotic vehicles emerged from the cave, and cut down a nearby forest. They levelled the ground, covered the surface with some kind of metallic plastic, and then returned to their cave.

Bronzed from the Vela sun, her straw-colored hair pushed up under her commander’s cap, Captain Burton led a squad of volunteers back into the caves on

a cautious reconnaissance mission. Inside the main cavern, the squad came upon the robots assembling the spine of a huge ship – a starship! Although the robots clearly knew the humans were there, turning to focus benign scanners on the volunteers several times, they obviously did not consider the Earthlings a threat. Captain Burton decided it was safe for humans to return to work in the caves, so long as people kept out of the robots' way.

Days later an abashed Farnsworth was finally coaxed back to the Precursor Control Computer to continue his research. Almost immediately, the professor discovered two significant facts. First, the construction process would soon transition out of the caves and assembly of the starship would continue on the planet's surface. Second, as far as Farnsworth could tell, the construction was going to take a long time.

The “long time” that Farnsworth predicted turned out to be nearly a decade. The colonists grew accustomed to the framework of a great starship looming above their tiny village. Day after day, a hundred robots moved across the surface of the vessel, welding and fitting, assembling and fabricating.

Then one day, without warning, the construction robots stopped work and returned underground. They assumed their original positions in the cave and shutdown completely. The cave was exactly the way the research team had first found it – silent, motionless. A flustered Professor Farnsworth frantically asked the Control Computer for an explanation, and got an immediate answer. There were not enough raw materials left to finish the vessel, nor were there suitable substitutes anywhere on the planet. A week of tests by Burton and her team proved the ship

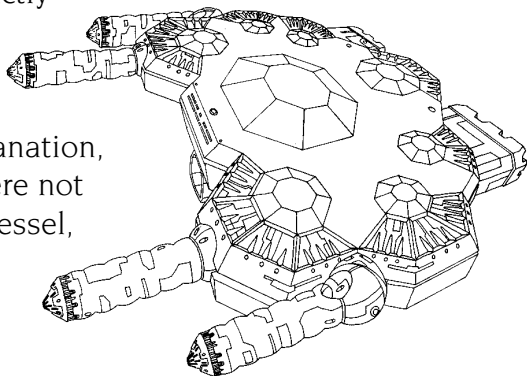

was complete enough to blast off from the surface of Vela II. But it would have to cruise slowly through HyperSpace, lightly armed, and with only enough room for a skeleton crew.

There was another problem. The controls for the vessel were not designed for humans. It became obvious from the interior layout of the starship that the Precursors were giants, and seemingly not bipedal. Levers were almost impossible to move, three people were required to actuate a single switch, and the chairs, beds and other furnishings were better suited for a wooly mammoth than a human.

Some kind of automated control system was needed. After mulling over the problem for several days, Captain Burton decided that the only answer was to remove the Central Control Computer from the cave and configure it to run the ship. Surely Professor Farnsworth knew enough about the Precursor computer system to give it whatever commands were necessary to take the ship back to Earth. Despite vehement protests from Farnsworth, the Captain ordered the Precursor's computer installed in the vessel. After 20 years marooned on Vela II, the colonists were at last ready to return to Earth.

Or were they? Pressed to begin programming the computer, Farnsworth broke down and admitted he didn't have the foggiest idea how to do it. It turned out he had never understood the incredibly complicated system. Instead, for years he had secretly employed the natural computer talents of a precocious young genius. This gifted child, now a young man, had been born on Unzervalt – the son of an officer from the Tobermoon and a Research Team engineer. Each night, after Farnsworth left the Control Computer console, the young boy had crept into the caves and tinkered with the computer. Within a few months, the child had established a rapport with the computer far beyond anything Farnsworth had accomplished. When the Professor discovered the boy's nocturnal activities, he used gifts and phony promises to win the child's

confidence, then talked the young genius into activating the entire complex. This time, the Captain did throw the Professor into the stockade.

Then Burton called the young man into her office and proposed a plan. She would command the starship, and he would serve as pilot, acting as the interface with the starship's Precursor computer.

With trepidation, *you* accepted.

The Return to Earth

After 3 months of intensive crew training, Captain Burton felt it was finally time to leave Unzervalt. You weren't so sure, weren't entirely comfortable with your new role as a starship officer. Burton listened as you expressed your doubts, then put an arm around your shoulders and re-assured you. You'd make a fine pilot. She'd trust a ship to you any time. Besides, all the plans were set. The two of you would lead the return to Earth, and once there send back a rescue ship for the colonists left behind. If necessary, Burton vowed, you would fight your way through the forces of the Ur-Quan Hierarchy.

You, above all, will remember that trip, for during the journey you went through a rite of passage. You left Unzervalt a boy and soon found yourself forced to be a man – to lead bravely and boldly and wisely. Think back. Do you recall the exhilaration of blasting off from the tiny planet where you were born – and the sheer terror later? Three days out, as you approached the perimeter of that cursed Oort Cloud, you found the Tobermoon – derelict and tumbling through space. The deep burns along her hull were mute evidence she'd seen combat. And lost. The discovery was, of course, a great shock to Captain Burton. Unconsciously she chewed her bottom lip, and for the first time her handsome face showed the awful strain

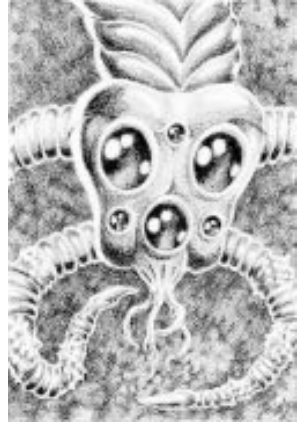

of the past twenty years. She'd been engaged to Captain Chi. Through two decades she'd clung to the hope she'd see him again, kept alive the dream they'd shared of marriage and children and a life together. Now the dream was shattered. She knew he was gone, even though there was no body to mourn over. Strangely, there were no bodies at all on board. And most of the important ship systems were intact. Do you remember how Burton wondered, tears brimming in her blue eyes, if Officer Chi and the other crew members had been taken prisoner? How her words conjured up a picture in your mind of the Earthlings being tortured – their ordeal provoking mirth in the soul-less Ur-Quan. With a few days work, the engineers brought the Tobermoon back to life. What came next changed your life forever. With Captain Burton the only one aboard qualified to pilot the Earth Cruiser, you were put in command of the Precursor starship. Admit it. Standing on the bridge – those epaulets the grieving but bravely smiling Captain Burton pinned on gleaming from your shoulders – you felt proud, sure of yourself. Hey, truth be told, at that moment you thought you were invincible.

Your confidence didn't last long, did it? With the Tobermoon leading the way, you and Burton pushed your ships out into HyperSpace – the parallel dimension where distances are fantastically compressed and interstellar travel feasible. Blazing white flashes surrounded your vessels and everything took on a crimson hue. Something up there wasn't right. Remember? Your body felt like it was in a vise and your head was spinning. You fought for control, forcing yourself to focus on the soft voice of Captain Burton radioing a command from the Tobermoon: "Set course for Earth."

A day later – you think it was a day, but now, looking back, you can't be sure – a sinister shadow began following you through HyperSpace. It moved fast, real fast. Within a couple of hours it had approached close enough to interact with your ship's hyperdrive field, pulling you both back into TrueSpace. At close range, the enemy ship looked like a pair of spinning red globes sur-

rounded by a crackling energy field. Some kind of glowing rod or energy beam connected the red globes. The alien craft built up speed rapidly as it zeroed in on the starship you commanded. Burton saw the attack coming and signalled you to warp out of the area immediately. A moment later you watched on your command console monitor as the Tobermoon flashed away on a trajectory to intercept the alien ship. As you pushed up into HyperSpace, you saw a crackling bolt of energy lance out from the alien vessel and strike the Tobermoon. Burton's craft wobbled violently, then veered off on an erratic course in the general direction of Unzervalt. The Alien craft was apparently satisfied with disabling the Tobermoon, for the strange ship made a 180 degree turn and rocketed at warp speed toward deep space.

Once your starship reached HyperSpace, you radioed the Tobermoon, only to learn that Captain Burton had been killed by the alien's unexpected attack. You felt sick to your stomach. Then you wanted to punch the bulkhead. You'd been half in love with Burton, you knew that now. Life stunk!

Captain Burton's death left you in full command of the mission to find Earth. You navigated the Precursor starship back on your original course, your mind swirling with all that had happened. A terrible doubt overtook you, gnawing at the edges of what had always been your strong self-confidence. Could you pull this off? You, a son of Unzervalt, born in a cave, raised on Ortog milk and Libixx meat. You, a man who'd never set foot in a university, never had formal space flight training beyond the crash course from Burton? You'd taught yourself everything, learning from reading computer programs and watching how engineers and scientists did things. The question ate at you now; had you been both a good teacher and a good student? Good enough at both to prepare you for the awesome task that lay ahead? Time would tell.

And time did tell. Five days after the alien attack you arrived at a stellar vortex leading out of HyperSpace. Your scanner showed the vortex spiralling down

STAR CONTROLL II

24

to a brilliant yellow star. You knew at once that this was the great star that had given life to your ancestors, the star your Earthling progenitors called the Sun! You warped down out of HyperSpace and took a navigational fix. You were just beyond the orbit of the ninth planet of the yellow star. Earth was the third planet out from the Sun. With all thrusters on, you can reach the blue planet in two days. A horrible thought flits across your mind. Had the Ur-Quan broken through the Alliance defense lines and attacked your ancestral home? Was there devastation? Had the cities been obliterated by nuclear weapons and the survivors left irradiated mutants, genetic freaks roaming the ashen landscape like primal apes? You'll know in 48 hours.

STARTING THE GAME

It shouldn't take much more than 5 minutes to install the game and begin playing Star Control II. Although we salute the expression of free will, you will get started faster if you follow the steps below.

Confirm System Requirements

- An AT-class IBM-PC compatible computer with a hard drive and 2x speed CD-ROM drive is required. A 20 MHz 386 machine or better is recommended. If you have a slower machine see Appendix II.
- Star Control II supports VGA and MCGA graphics only.
- You will need at least 580,000 bytes of low DOS memory available when you start the game.
- You will need at least 9.2 megabytes available on your hard disk if you want to play Star Control II from your hard drive rather than play off the CD-ROM.

Installing Star Control II onto your hard drive

Star Control II can be installed on your hard disk. Here's how:

- 1 Turn on your computer.
- 2 Insert the Star Control Collection CD-ROM into your CD-ROM drive (usually D or E).
- 3 In DOS, a DOS Window, or MS-DOS mode, make a directory for the game on your hard drive (usually C). Change to the root directory by typing `CD\ <Enter>`.
- 4 At the DOS prompt, type `MD STARCON2 <Enter>` to create the "STARCON2" directory.
- 5 Change to your new directory by typing `CD\STARCON2 <Enter>`.
- 6 At the new prompt, type `COPY D:\STARCON\STARCON2*. * <Enter>`,

where D is the name of your CD-ROM drive. This will copy the game from your Star Control Collection CD-ROM to your hard drive, and install Star Control II on your C drive, in a directory called C:\STARCON2.

After you launch the game, you will be presented with choices:

- Start New Game: The game starts at the very beginning, prompting you to enter your captain's name.
- Load Saved Game: You are presented with a list of saved games to choose from. If you change your mind and want to start from the beginning, press the Spacebar.

Start-up

Follow these steps to start the game:

- 1 Make sure your computer is on.
- 2 Place the Star Control Collection CD-ROM in your CD-ROM drive.
- 3 If you have Windows, exit from Windows to DOS. If you have Windows '95, restart in MS-DOS mode. If DOS is your operating environment of choice, you should already be where you need to be.
- 4 Change to your CD-ROM drive by typing the drive name (usually D) and a colon. Press <Enter>.
- 5 At the CD-ROM drive prompt, type STARCON <Enter>.
- 6 Choose Star Control II in the introductory menu. When you are shown the picture of a star, hit the <Space Bar>.

If you have copied the game to your hard drive, exchange the following steps for their equivalents above:

- 2 Since the game is on your hard drive, you don't need the Star Control Collection CD-ROM in the drive.
- 3 Follow Step 3 above.
- 4 From the root directory of your hard drive (usually C:) change directories to the STARCON2 directory by typing CDSTARCON2 <Enter>.

- 5 At the C:\STARCON2> prompt, type STARCON2 <Enter> to launch the game.
- 6 When you are shown a picture of a star, hit the <Space Bar>.

PLAY CONTROLS

Star Control II can be played entirely from the keyboard, or you can use a joystick for most game activities. Joysticks are automatically detected and calibrated at runtime, so keep your joystick centered and motionless until the game begins.

Menu Controls

Many aspects of gameplay are accessed by a system of menus. Each menu will list various options which allow you to give a command, select a ship, pick a phrase, etc. To select menu items with the keyboard, use the cursor arrow keys to highlight the item you want, then press Enter. In some cases, when you pick a menu item, you will be given a new sub-menu of options. To leave a sub-menu and return to the previous menu, press the Spacebar.

Keyboard Menu Controls

When selecting menu items, the joystick acts just like the cursor arrow keys. Pressing Button #1 is the same as pressing Enter, and pressing Button #2 is the same as pressing the Spacebar.

Button #1 selects the highlighted option, and Button #2 returns you to the previous menu.

Joystick Menu Controls

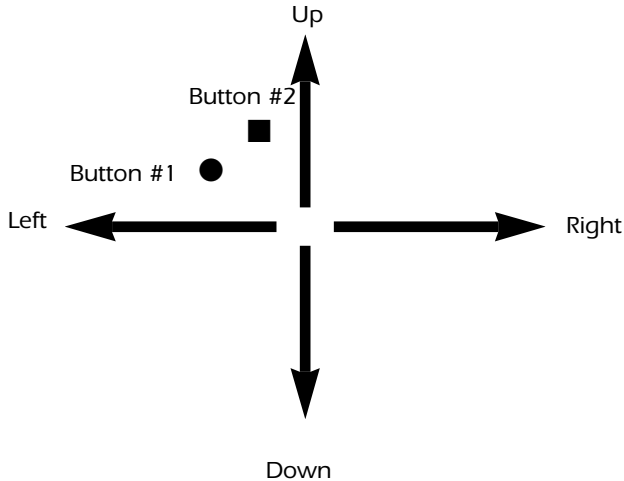

Combat Commands

In combat, you can control your ships with either the joystick or the keyboard. You can redefine the control keys with the separate program, KEYS.EXE. The KEYS configuration will not be saved unless you are playing the game from your hard drive. In the SuperMelee bonus game, there can be two human players, and each uses a separate joystick or area of the keyboard.

Default Keyboard Combat Controls

	Keyboard #1	Keyboard #2
Use Special Power	N	1
Rotate Counter-Clockwise	M	2
Rotate Clockwise	,	3
Thrust	.	4
Fire Main Weapon	?	5

Joystick Combat Control

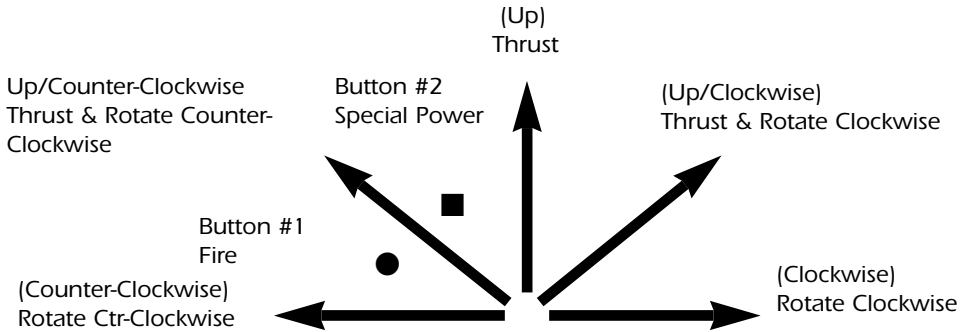

NAVIGATION

The core of *Star Control II* is space flight, both in combat and exploration. Whether you are traveling from planet to planet or from star to star, or engaging in combat, the controls are the same. To go somewhere, you rotate your ship in the direction you want to go, and then press the **Thrust** key.

The Effects of Inertia and Gravity

When ships are navigating in **Star Control II**, they are under the influence of two physical forces; inertia and gravity.

Inertia is the tendency of an object in motion to remain in motion. All moving objects have inertia, and the faster they go, the more inertia they possess. When you let your foot off the gas in an automobile it slows and comes to a stop because there are many forces of friction acting against your motion, like air-resistance, the roughness of the road, and the car's mechanical parts rubbing against each other.

In normal space, these resisting forces of friction are virtually nonexistent. Any object in motion (like a spaceship) will keep moving at the same speed until something stops it. The only way for a spaceship to stop itself is to turn in the direction opposite its line of travel and thrust until it comes to a stop.

Gravity is the natural attractive force that exists between all objects. This force is usually too small to be noticeable, unless an object is terrifically massive – like a sun or planet. In **Star Control II**, the only situation in which your ship will be affected by gravity is in space combat. As you approach a planet, its gravity will begin to affect the course of your vessel, bending your path toward the center of the planet.

Inertial ships can make use of planets' gravity fields to achieve higher than normal velocities by performing the Leyland Gravity Whip maneuver. To use this trick, simply move past a planet, and while you are close to the planet, thrust continuously without rotating your vessel. Then, as you fly away from the world, stop thrusting and coast at high velocity.

Note: Use caution when performing this maneuver to avoid striking planets, which can damage your vessel.

Interplanetary Travel

Interplanetary navigation is travel between planets within a single star system. The interplanetary navigation screen is represented as a sun surrounded by a number of planets, each situated on an ellipse describing its orbital path around the sun. As you navigate your ship toward the center of the star system, the view expands to show you a more detailed view of the inner planets. When you approach a planet, the view will expand once more, showing you a close-up view of the world, plus displaying any moons which may be orbiting the main planet.

Encounters in Interplanetary Space

Though most of the known area of space is still uninhabited, you are likely to encounter groups of alien starships anywhere in your voyages. In the Interstellar view, these ships are represented as small icons, which can be travelling between planets, or patrolling space. At typical interplanetary distances, you will be unable to ascertain the exact configuration of an enemy task force. The actual composition can be determined only when you make contact with the ships.

To engage an alien task force, simply bring your ship into contact with the icon. But beware, the outcome of such an encounter may be sudden combat.

Entering Planetary Orbit

Once you're in a star system, you may want to visit the planets there. Your flagship itself is not designed to land on a planet, but you can enter a planet's orbit for a closer look and then send a Lander down for a more thorough investigation.

To enter a planet's orbit, maneuver your vessel until it touches the center of a planet. You will then automatically enter the planet's orbit.

Planet Types and Descriptions

Planets are aggregated matter which forms around suns. The size, composition and chemistry of each planet is unique, but the majority of planets fall into a few general categories which are described below.

Gas Giants

These planets are huge balls of gas composed of light elements such as hydrogen or helium. Since gas giants have no surface to speak of (just an

increasingly dense fog of gas), ships cannot land on this type of planet. Although there has been some discussion of harvesting the upper atmosphere of gas giants with enormous "scoop-ships," your flagship is incapable of gleaning any useful minerals from such planets. To date, no complex life-form has ever been found in/on a gas giant; however, research into this field has been minimal.

Water World

Like Earth, most other water worlds are large rocky planets with nickel-iron cores, fluid mantles, and a thin shell of H₂O covering some or all of the surface of the planet. Depending on the distance from primary (the star about which the planet orbits) the surface can be solid ice, liquid, or gaseous vapor. Due to the unusual chemistry of water, life is quite common on water worlds having an average surface temperature in water's phase-change range, 0-100° centigrade.

Selenic World

Selenic worlds are small and not dense, being composed of light, common minerals and metals. Such planets rarely possess an atmosphere. Earth's moon, Luna, is a perfect example of this kind of world.

Dust World

The surfaces of these planets are composed of silicates and metal oxides, with little or no usable mineral deposits. The thin atmosphere found on dust worlds will occasionally support a minimal eco-system.

Hydrocarbon World

Hydrocarbon worlds are similar to water worlds, but instead of H₂O these planets are covered with a layer of richly varied, inorganic hydrocarbons such as ethanol. Small deposits of useful minerals have been found on such planets, but they are most notable for their ability to support life.

Primordial World

Large and rocky, these planets follow the typical metal-core, silicate sheath configuration found in so many worlds of this size. The primordial world gets its name from the conditions found on its surface when the primary supplies enough energy to volatilize the planet's dense layer of CO₂, producing a super-thick, incredibly hot atmosphere.

Metallic World

Often found in the first or second orbital position, metallic worlds have been subjected to such incredible heat that the lighter materials burn-off the planet, leaving a small, dense ball of heavy metals and minerals. Although such metallic worlds are exceptionally valuable finds for their abundant resources, beware their occasionally intense gravity fields.

Reduction World

The reduction world is very similar to the water world, except that the predominant surface gas is not oxygen, but instead methane and ammonia.

Radioactive World

These rare planets have a much higher than normal surface concentration of valuable radioactive elements, indicating either atypical gas composition, or unusual mantle convection processes.

Other Planet Types

There is no doubt that there are many other, less common types of planets to be found in the galaxy, each with their own unique characteristics. It is up to you to locate these unknown worlds, and determine their nature.

“Pushing” Up into HyperSpace

To leave a star system and enter HyperSpace you will first have to leave the

gravitational field of the primary star. To do so, fly away from the star until you reach the outer limits of the system. At this point your flagship will automatically engage its “pushers,” lifting you out of TrueSpace, and projecting your ship into the adjacent dimension of HyperSpace.

HyperSpace Travel

All the myriad ways between the stars may be reached through HyperSpace, a conveniently accessible alternate dimension which shares time-space with our own universe. The set of physical laws in HyperSpace is substantially similar to our own (allowing starships and their occupants to survive there), but certain key differences involving the speed of light permit fantastically accelerated transit between stars.

While in HyperSpace, you can monitor your surroundings via the small tactical display in the lower right corner of the screen. On this display, stars are shown as bright dots and alien vessels are shown as dark dots. The Ariloulaleelay, who seem most familiar with the nature of HyperSpace, have intimated that there are other “things” in HyperSpace, some of which are “good,” while others are “extremely bad.” Presumably, these “things” the Arilou refer to would also appear on the tactical display, though what they would look like is unknown.

Things look strange in HyperSpace. The subtle differences in physics cause a substantial red-shift in the visible spectrum, casting everything in a blood red light. The sudden explosions of bright light and coruscating energy bursts which are common in HyperSpace have proved harmless, and it is theorized that these are manifestations of objects which are moving quickly through HyperSpace into adjacent dimensions.

Fuel Use in HyperSpace

In HyperSpace, gravity and inertia do not function as they do in our

dimension. Once you cease thrusting, your ship will gradually come to a halt, as though some invisible force were constantly dragging on your vessel. This is, in fact, the case. To continue travel, you have to thrust constantly, and this uses huge amounts of fuel. As a general rule: **DO NOT RUN OUT OF FUEL IN AN ALIEN UNIVERSE.** Few have lived to tell of the experience.

Encounters in HyperSpace

All known star-faring races use HyperSpace as their transit corridor between stars. Occasionally, such ships may meet in this alien dimension, and the intersection of their masses causes them both to drop down from HyperSpace into the interstellar void. The confrontation between ships then takes place in the traditional manner, and is resolved in words and/or weapons exchanges.

Returning to TrueSpace

The passage back to TrueSpace is made via the transdimensional vortices produced by stellar gravity fields. To enter a star system, move your ship onto the center of a stellar vortex. You will automatically transition out of HyperSpace and into the star system.

SHIP COMMANDS

Your flagship is capable of many activities beyond navigation. You access these abilities through the Flagship Command Menu. You can enter this menu from Navigation by pressing the **Spacebar** or **Button #2**, then moving the highlight to the desired command and pressing **Enter**. The Commands are as follows:

Starmap

This command displays a map of the stars in the known region of space.

To find out the name of a star, move the flashing highlight on top of it. The name of the star and the fuel necessary to reach it will then be shown in the secondary and tertiary data displays at the top of the screen. The grey oval surrounding your position represents your range with your present fuel supply. Remember, you use fuel landing on planets and escaping from battle, so this range circle can change even if you are not in HyperSpace.

Note: Planetary excursions require fuel, and may significantly affect your range.

You can expand the Starmap to get a clearer look at a viewed region by pressing the **Insert** key. Use the **Delete** key to return to the original view. To scroll your view of the Starmap when you are zoomed-in, move the cursor off the edge of the screen, and the view will automatically re-center.

Alien Spheres of Influence

When you acquire information about an alien race, either through friendly conversation or via minute inspection of enemy ship wreckage, the Starmap will display what you have learned by showing the aliens' sphere of influence. This appears as a colored circle on the Starmap, labelled with the name of the appropriate alien race. The size of the sphere is an indicator of the overall strength of an alien's entire star fleet. Although these Spheres of Influence are usually centered around their native homeworld, they can move. Therefore, you might want to make regular examinations of your star map.

Using the Autopilot Feature

You can fly to any star in space manually, using the navigation controls described above. As a convenience, you can also have an automatic pilot fly your vessel directly to a desired star or location in HyperSpace.

To set a course for automatic pilot, start from the Starmap. Position the cursor on your desired destination and press **Return**. A line of blue dashes will show you the course plotted by the autopilot computer. To engage, press the **Spacebar** or **Button #2**. You will automatically enter navigate mode and begin flying to your target. As long as "AUTOPILOT" is flashing, you're headed for your destination.

You can activate the autopilot while in orbit, in interplanetary space or in HyperSpace. If you have set a star as your destination, the autopilot will disengage when you enter the target star system.

To interrupt the autopilot at any time and assume manual control of your flagship, press any of your normal navigation controls, and the autopilot will disengage. To resume automatic flight, return to the Starmap and repeat the procedure described above.

Scanning a Planet

Many planets exhibit important and interesting aspects, such as valuable mineral deposits, unique life-forms, and, potentially, items and artifacts left by other intelligent species. To avoid tediously exploring the surface of every planet, you can make a quick evaluation of each planet from orbit by using your flagship's scanning equipment.

To get a basic scan of a planet, choose **Scan** from the Flag-ship Command Menu. This will display general information about the planet in the rotating planet display, including:

Planet Type: A general description of the planet.

Orbital Radius: Distance from its primary star in A.U.s (the distance from

Sol to Earth is 1 A.U.).

Temperature: The average surface temperature in degrees centigrade. The hotter the planet, the more prevalent are “hotspots” on the planet’s surface, making travel there more dangerous.

Tectonics: This value gives a general indication of the frequency of large seismic shocks within the planet’s surface. There are 8 classes of activity, with 1 being least dangerous and 8 being a stupendous tectonic upheaval.

Weather: This factor measures the force and density of disturbances within a planet’s atmosphere. Like tectonics, there are 8 classes of weather. The most dangerous effect of weather on a lander is lightning, which strikes more often on planets with higher weather factors.

Atmospheric Pressure: Pressure is a measure of the density of the gasses which make up a planet’s atmosphere. Atmospheric pressure is measured in Earth-standard units.

Mass: The mass of a planet is measured in Earth-standard units, where 1.0 is equal to the mass of Earth.

Radius: The radius of each planet is also measured in Earth units. The mass combined with the radius determine a planet’s gravity.

Gravity: A planet’s gravity affects how much fuel it costs to land on the world. Gravity is measured in Earth units.

Length of Day: This measurement reflects how long it takes for the planet to revolve fully about its axis.

Axial Tilt: Axial tilt describes the angular difference between a planet's rotational axis, and the axis of its orbit around the primary star. Typically, the greater the axial tilt, the greater the planet's seasonal differentiation.

Specific Scans

Based on what you have learned from the basic scan, you may wish to make a more focused scan of the planet's surface. These scans include:

Mineral Scan

This function paints low-power, deep-radar waves across the planet, and interprets the resulting echoes into dots on the mineral display, showing the location, size, and type of each significant mineral deposit on the surface. The diameter of the dot indicates the size of the deposit, and the color informs you what type of minerals are in the deposit.

MINERAL CHART		
Mineral	Color	Value
Common	Cyan	1
Corrosive	Red	2
Base Metals	Gray	3
Noble Gases	Blue	4
Rare Earths	Green	5
Precious Metals	Yellow	6
Radioactives	Orange	8
Exotics	Purple	25

Of course, each planet has many more resources well beneath the surface. However, your lander is not equipped to access these minerals, and must limit itself to what resources are readily available.

Biological Scan

When conditions are right – the temperature, the atmosphere, the amount of water – certain planets develop life. The vast majority of life-forms are simple, viral or bacterial organisms, and present little to interest anyone but a specialist, or someone whose body has become infested with such creatures. Larger, more sophisticated life-forms tend to be more interesting. All living creatures change the environment around them, absorbing light and/or food, and excreting less pleasant substances. Your flagship is equipped with Biological Scan facilities which use such environmental changes to pinpoint large creatures.

Energy Scan

The energy scan will locate power being generated on a planet's surface, providing the generator is not shielded, or otherwise concealed. The primary use of this function is to find alien ships or installations on a planet's surface.

Dispatching a Lander

Scanning only provides information about what's on a planet's surface. To retrieve something of value, you will have to go down to the surface. While your flagship is unsuited for such a journey, it carries planetary landing vehicles, which can make repeated trips to and from planetside. Your flagship can hold up to 10 landers.

To send a lander to the surface, choose **DISPATCH** from the Scan Menu. A flashing cursor lets you set your landing position. Move the cursor with the **Cursor** keys and press **Enter**. The fuel necessary to make the trip is displayed in the flagship data window.

Note: If you have lost all your landers, you will be unable to visit a planet's surface. You will have to return to the Earth Starbase for more landers.

Planet Surface Exploration

When you've landed on an alien world, be careful because the conditions there could be quite treacherous. Planet landers, though quick and maneuverable, are not exactly invincible space tanks.

Lander Status Display

To the left of the planet map is the Lander Status display showing the lander's crew (a maximum of 12), its present cargo, its data stores, and its protective devices.

Once you have launched a lander from your flagship, you will see it fly off toward the planet. Your command area will then be replaced by a magnified image of the vehicle landing on the planet's surface.

After you have arrived on the planet surface, you can begin maneuvering the lander vehicle using your normal starship navigation controls, though you will have to thrust continuously to move forward. As you move about the surface, the magnified view will scroll to keep your vehicle centered in the view.

Returning to the Flagship

You can return from the surface to the flagship at any time by pressing the **Spacebar** or **Button #2**.

Gathering Minerals

Mineral deposits are shown on the planet's surface as colored dots (see the Mineral Chart, for details.) To pick up a mineral deposit, simply run over it with your lander. You will hear your harvesting equipment gather the material and bring it aboard. The Cargo Status Bar will change to reflect

the presence of the minerals brought aboard, and show how much room you have left in the lander. If you try to gather a deposit when the lander is full, you will hear an unpleasant protest from your harvesting machinery, and you will be unable to load the deposit.

To gather additional minerals, you will have to return to the flagship and off-load the material into your Cargo Bays.

Planetary Hazards

Alien worlds can be extremely hostile when compared with Earth, and can cause the unfortunate demise of your lander's crew. If a disaster should strike, and your entire crew be eliminated, your lander will be destroyed, and with it all the minerals and/or devices you had collected. When visiting dangerous planets, it is wise to keep a finger on your recall control, just in case you need to leave in a hurry.

The hazards you will encounter include:

Earthquakes: These massive tectonic upheavals appear on your magnified display as expanding concentric rings. The longer the lander is punished by an earthquake, the more of your lander's crew will perish.

Lightning: Unpredictable and unavoidable, lightning can dance around your lander for minutes, then zero in on your vessel and wipe-out half your crew in seconds.

Hotspots: On planets with high surface temperatures, you will encounter "hotspots," shifting regions of intense heat which are incredibly destructive. Avoid these hazards at all costs!

Native Life-forms: On rare occasions you will encounter interesting life-forms on alien planets. Unfortunately, "interesting" usually means danger-

ous. You will be unable to ascertain just how dangerous a creature is until it attacks, and it may then be too late. Many life-forms will flee from your lander instead of attacking. Some creatures are sessile and just sit there.

Collecting Life-form Data

To collect life-form data, you need to thoroughly analyze the creature. To do so, you must first prepare the life-form for study. This is accomplished by aiming your lander at the entity and pressing **Return** to fire a stun blast. When the creature is sufficiently incapacitated, it will transform into a glowing specimen canister which can then be retrieved at your leisure by running over it with your lander. Don't worry, this doesn't hurt the creature at all.

Each species of alien life is different. Some are fast and others are slow. Some look like jumping plants, while others look like zeppelins with teeth. Some creatures are stunned by a single zap from your lander, while others won't succumb until they've been shot ten times. As a general rule, avoid physical contact with alien creatures unless they are stunned and properly contained. Remember, they may bite.

Unfortunately, in general the more dangerous the alien life-form, the more valuable its data will be. Exactly where and with whom you exchange life-form data for valuable commodities is up to you to find out.

Flagship's Manifest

This option lets you view and manipulate various detailed aspects of your flagship and combat fleet.

Checking Cargo

The amount of minerals or other cargo your flagship can carry depends on how many Cargo Bays you have built into your ship. When you choose

CARGO, the game will display the different types of minerals and how many units you presently possess, as well as the remaining FREE CARGO space left on your ship. The display also shows how much information you have gathered on life-forms.

Should you wish to **DISCARD** some minerals (perhaps to make room for other, more valuable minerals), select the **DISCARD** command and then press **Enter** or **Button #1**. Next, move the flashing cursor over the type mineral you wish to discard and press **Enter** again. Each time you do so, one unit of the selected mineral will be discarded. You cannot retrieve minerals once you have discarded them.

Using Devices

During the course of the game, you will find, buy, or otherwise obtain devices which you will carry aboard your flagship. To manipulate such items, choose **DEVICES** from the Command Menu. A list of the devices aboard your ship will be displayed in the flagship status area. After you have highlighted the device you want to activate, press **Enter** or **Button #1**. To leave the device list and return to the Command Menu, press **Spacebar** or **Button #2**.

Ship's Roster

This command is useful for moving crew between your flagship and your combat vessels. After choosing **ROSTER**, you can **ASSIGN** crew from your flagship to a combat vessel, or **RECALL** crew back to your flagship. After you have selected the desired command, highlight the ship you want to transfer crew to or from, and then press Return to effect the transfer, one crew member at a time. The number of crew aboard the selected ship is displayed in the Flagship Data Window. When you are finished assigning or recalling crew, press the Spacebar or Button #2 to return to the Command Menu.

Game Options

By choosing **GAME** from the Flagship Command Menu, you gain access to several commands which let you **SAVE** your game in progress, **LOAD** a game in progress, change play **SETTINGS**, or **QUIT** the game altogether.

Saving a Game in Progress

You can never be sure just when you're going to be blown to tiny bits by an evil alien, so it is a good idea to save your game as you play – especially right before a battle, or just after you've struck it rich mining. That way, should you meet an untimely end, all your hard work will not have been in vain.

When you choose **SAVE GAME**, the program will display a list of numbered Game State Slots on the left side of the screen. Move the flashing cursor up or down to pick the Game State Slot in which you want to save the current game. Although there are 50 slots available, only ten are shown at once. To scroll the entire selection of slots, move the highlight up or down beyond the edge of the list.

When you have picked a slot, press **Enter**. The entire slot will highlight, and you can now type in a brief description of where and/or when you are situated in the course of the game. If the slot already has a description, you can use the **Backspace** and **DEL** keys to erase the old description, if desired. When you are satisfied with the description, press **Enter**. The game will save the necessary information, and return to the Flagship Command Menu.

Loading a Saved Game

After choosing **LOAD** from the Game Menu, highlight the Game State Slot with the desired description and press **Return**. The game will automatically load and return to normal play.

Changing Game Settings

This command allows you to configure the way the game plays to better suit your personal preferences.

Music Level

This command toggles music on and off.

Sound Level

This command toggles sound effects on and off.

Reading Speed

After choosing **READING**, you can either pick **+SPEED**, which speeds up the rate at which text is displayed in the game, or you can choose **-SPEED**, which slows down text display.

Combat

This submenu of options allows you to change how the game conducts space combat. By modifying these settings you can have the computer fight your battles for you, and/or speed-up how fast the game conducts the combat.

Cyborg: If both your arms are broken, or you are suffering from a serious disease, you may wish to toggle the CYBORG setting on and have the computer fight your battles for you. Of course, some players have been known to use this feature WITH NO ADEQUATE EXCUSE! Harumph!

Resolving Combat: By using the **+Resolve** and **-Resolve** options, you can speed-up your Cyborg-controlled battles. The active setting is shown in the Flagship Data Window. The available settings are:

- **Normal:** The rate of play is held to a consistent speed which is

similar on most computers. This is the default setting.

- **No Delay:** The program unleashes the full power of the computer, allowing battles to be greatly accelerated on fast computers.

- **Flicker:** The same as No Delay, but now the program shows only a sample of the calculated ship and weapon positions, creating a flickering, fast-forward display.

- **Fastest:** To achieve maximum speed, the program displays no ship-to-ship graphics, just sound. The status areas are updated continuously, showing the progress of the furious conflict.

Remember, the Resolution setting is effective only when the Cyborg is turned ON.

Changing Names

You will probably want to use this command at the beginning of the game to establish the name of your character and to christen your flagship. After choosing NAMES, you can pick CAPTAIN or FLAGSHIP. After you have made your selection, the current name in the Flagship Status Window is erased, and you can enter a new name in its place. To erase the old name, use the Backspace and DEL keys. When you are done, press Return.

Quitting the Game

To leave Star Control II and return to DOS (perhaps to play a game of SuperMelee!), choose QUIT and then choose YES, QUIT to confirm your departure.

THE EARTH STARBASE

Early on in the course of the game, you will gain access to a huge Starbase orbiting Earth. This spacestation will serve as your base of opera-

tions for the remainder of the game, providing you with enhancements for your flagship, additional combat vehicles, and crew.

To visit the Earth Starbase, go to the Sol star system and approach Earth until the view expands to show you the Earth-Luna system. The Starbase is the object in orbit between the planet and the moon. Navigate your flagship until it touches the center of the Starbase and you will automatically take up position adjacent to the space station.

Once you arrive at Starbase, you have the following choices: **STARBASE COMMANDER, OUTFIT STARSHIP, SHIPYARD, DEPART STARBASE.**

The Starbase Commander

This command initiates a conversation with the commander of the Earth Starbase. He is the source of much information regarding the Ur-Quan and various developments which will turn up over the course of the game.

Transferring Minerals to the Starbase

In order to build new equipment for your flagship, build additional combat vehicles, or commission more crew, you have to supply the Starbase with raw materials. These materials most often take the form of minerals which you have gathered from the surfaces of alien worlds. To transfer resources to the Starbase, initiate a conversation with the Commander and select the option, "Commander, I have material to off-load." The Commander will then remove the minerals from your vessel and inform you of their value.

Outfitting Your Flagship

At the beginning of the game, your flagship is incomplete. You will spend much of the first part of the game gradually building it into one of the most powerful vessels in the galaxy. To do so you must gather mineral or other resources from across space and bring them back to the Starbase.

When you choose **OUTFIT FLAGSHIP** from the Main Starbase Menu, you will see a schematic display of your vessel, its components, its present fuel supply and the landers you have on board.

Flagship Characteristics

The flagship schematic display also lists the following characteristics:

Turning Rate: The rotation rate of your flagship in combat, HyperSpace and interplanetary travel, based on the number of turn jets on your vessel.

Maximum Velocity: Your ship's speed in combat, Hyper-Space and interplanetary travel based on the number of thrusters your ship possesses.

Combat Energy: The speed with which the energy for your weapons is replenished during combat. The more Dynamos you have on board your flagship, the faster energy will be regenerated.

Fuel

Your flagship requires fuel to travel through HyperSpace and to send landers down to the surfaces of alien worlds. Your ship always has a fuel reserve capacity of 10 units of fuel and is initially equipped with one Fuel Tank Module with limited capacity. To increase your present supply of fuel one unit, up to your maximum fuel capacity, select **+FUEL**. To transfer fuel from your ship back to the Starbase (recouping some of its value) choose **-FUEL**. To increase your fuel capacity you will have to buy additional Fuel Tank Modules.

Flagship Enhancement Modules

The Precursors who designed your flagship 250,000 years ago (while humans were still little more than smart monkeys), would have really appreciated the Swiss Army Knife. This is apparent in the way your ship is built. The superframe of the flagship is strong but minimal, providing little

better than a solid framework ready to accept additional pieces of equipment. These self-contained equipment packages are called “Modules.” You can build additional modules and attach them to your vessel.

Modules come in four different kinds: Thruster, Attitude, Lander, and Multi-Function.

Thruster and Attitude modules affect how your ship handles in space. The more Thrusters you have affixed to your flagship the faster it goes. Increasing the number of Attitude modules allows your ship to turn faster. You can have a maximum of 11 Thrusters and 8 Attitude modules. Landers are necessary for making journeys to planet surfaces. You may need more than one lander because hostile conditions on planetside may result in the untimely destruction of a lander now and again. You are limited to a maximum of 10 landers.

Multi-Function modules fit along the spine of your flagship and can transform it from a colony space-ark to a mineral processing platform to a battleship of unrivaled power. The characteristics of your flagship depend on the selection of Multi-Function modules you make. You are limited to a maximum of 16 Multi-Function modules. The optimum lay-out of modules for your starship will depend on your specific mission, and your style of play.

Adding and Removing Modules

To add a module to your flagship, choose **+MODULE**. The game will then display a list of available modules in the Flagship Status Window. Next to each module is its cost. Move the highlight to the module you wish to add and press **Enter**. A flashing cursor will now appear on the schematic display, allowing you to position the module on your vessel. Move the cursor with the **Cursor** keys and press **Enter**. The cursor will

now move back to the module list so that you can add more modules, if desired. When you are done adding modules to your flagship, press **Spacebar** or **Button #2** to return to the Command Menu.

There is no perfect configuration of modules, so at times during the game you will want to replace a module on your flagship. To remove a module and recover most of its value, choose **-MODULE** from the Command Menu. A flashing cursor will then appear on the schematic display of your vessel. Use the **Cursor** keys to move the highlight to the module you wish to remove and press **Enter**.

Note: You cannot remove modules which contain resources such as fuel in Fuel Tanks or minerals in Cargo Bays. If you want to remove such modules, first empty them.

For a detailed list of module descriptions, see **Appendix VI – Flagship Modules**.

The Shipyard

In addition to enhancing your flagship, the Earth Starbase can also build additional combat vessels to escort you on your travels through space. To build combat ships, or commission new crew members for your flagship or combat vessels, choose **SHIPYARD** from the Starbase Main Menu.

At the top of the Shipyard Screen you will see a schematic of your ship which shows how much fuel, cargo, and crew you have aboard. Beneath this schematic are the 12 ship hangars in which you can build your fleet of combat vessels.

Adding and Removing Crew

To add new crew members, select **+CREW** from the Shipyard Command

Menu. A flashing cursor will appear on the schematic of your flagship. Move the cursor using the **Cursor** keys to the ship to which you want to add crew, and press **Enter**.

Additional crew are shown as green dots on your flagship. Your maximum crew level depends on how many Crew Pod modules you have attached to your flagship. Each Pod holds up to 50 crew. For combat vessels, the present/maximum crew levels are shown in text beneath the image of each ship.

When you have added sufficient crew members, you can then move the cursor to another ship, or press the **Spacebar** to return to the Command Menu.

To remove crew from your flagship or a combat vessel, choose **-CREW** from the Shipyard Command Menu, then move the flashing cursor over the desired ship and press **Enter**. Each time you do so, one crew will be transferred back to the Starbase, and you will recoup most of the crew's value. When you are done removing crew, press the **Spacebar** to return to the Command Menu.

Combat Vessels

You may add up to 12 escort vessels which will travel with and fight for your flagship. These ships may represent a less expensive alternative for defending yourself, rather than spending a great deal of your resources on transmogrifying your flagship into a battleship.

Adding Combat Vessels

To add a ship to your escort fleet, choose **+SHIP** from the Command Menu. A list of the available ship types and their costs will then appear in the Flagship Status Window. Move the highlight to the ship you wish to

purchase and press **Enter**. A hangar will then open, showing the newly commissioned ship. Remember, ships arrive in their hangar with only one crew member (the captain) onboard. It is highly recommended that you immediately add maximum crew to each new vessel as it is built. When you are done building ships, press the **Spacebar** to return to the Command Menu.

Note: The selection of ships you can build will be very limited at the beginning of the game. To expand this list, you need to make alliances with other alien races. You may only receive these “gift ships” from other races if you have room in your fleet. Therefore, you may want to keep two or three open slots.

Also, these gift ships may be sold for Resource Units, but you cannot rebuild the vessels. Once they are sold, they are gone.

Removing a Combat Vessel

To decommission (remove) a combat ship from your fleet, and recoup most of its value, choose **-SHIP** from the Shipyard Command Menu. Move the flashing cursor over the ship you want to remove and press **Enter**. Any crew on board the ship will be automatically removed, and their value added to your available resources. When you are done removing ships from your fleet, press the **Spacebar** to Return to the Command Menu.

Leaving the Starbase

When you are ready to leave, choose **DEPART STARBASE** from the Main Starbase Menu. You will appear in interplanetary space, near Earth.

ENCOUNTERING ALIEN RACES

You can encounter alien ships in HyperSpace, in interplanetary space, and in orbit around certain planets. Some encounters you can avoid, others are inescapable. In some situations, you may have to chase down the aliens to make contact with them.

Such an encounter may lead to a friendly conversation, or you may immediately find yourself in battle. In most situations, you will make the choice to talk or fight.

Combat Segue

Unless you have established friendly relations with an alien race, whenever you encounter their ships you'll hear the "RED ALERT" klaxon and the screen will change to display the combat segue screen. On this screen, you will see the composition of the alien task force, as well as the closest planetary body. At this point, the Command Menu gives you the choice of talking with the aliens or attacking them. You may also use all the GAME options so that you can save the game at this point, should you desire to do so.

Note: The Combat Segue Screen normally displays the exact number of ships you have encountered. However, if alien ships fill the entire screen, you are facing an enemy task force of UNLIMITED size which you CANNOT defeat in combat. If the task force is between you and something you want, you will have to figure out what is necessary to appease the aliens, or devise a clever plan to trick them into leaving.

Conversing with Aliens

When you choose **CONVERSE** from the Command Menu, you automatically open a hailing frequency to the enemy vessel. The advanced Precursor computer system aboard your vessel will translate messages to and from your ship with near perfect clarity.

When the alien commander responds, his/her/its image will appear on your screen. Depending on the alien race's general disposition, and/or your relationship with them up to that point, the alien's greeting could range from a friendly, "Hello, we come in peace. How are you?" to the more traditional, "Prepare to die, puny Earthling." The latter phrase would probably end the conversation, and cause an immediate transition to combat.

Conversations transpire in a familiar manner. You say something, the other being says something, and the process repeats until one of you is sufficiently angry, bored, or otherwise ready to end the conversation. The interesting part of communicating with an alien (or anyone else for that matter) is in **what** you say.

When it is your turn to say something, you will be presented with a set of possible phrases. Depending on what phrase you choose, you may alternately befriend or enrage the alien you are talking to. After you have decided on the phrase you wish to speak, highlight it with the **Cursor** keys and press **Enter**. The alien will respond, and either you will be given another set of phrases or the conversation will come to an end – possibly initiating combat. To repeat the alien's last phrase to you, press the **Spacebar** or **Button #2**.

Attacking Aliens

If you choose **ATTACK!** from the Command Menu, or your conversation ends on a sour note, you will automatically go into COMBAT MODE.

COMBAT

One of the most important and fun parts of **Star Control II** is ship-to-ship tactical combat. If you played Star Control, you already know how this part works. If you are new to this aspect of the game, you will want to read this section carefully, and then use the SuperMelee program to practice your combat skills. If you are totally inept in fast action situations, and just want to watch the battle unfold, set the CYBORG option (see page 39 for details) and let the computer fight for you.

Note: Setting the Cyborg option is comparable to taking a shower while wearing a raincoat.

Selecting a Ship

When combat is initiated, the screen clears. If your flagship is flying without any escort vessels, it immediately warps into the combat zone. If you are accompanied by one or more combat ships, you must pick the first ship to fight. Move the flashing cursor over the flagship or one of the escort vessels and press **Enter**.

The Battlefield

Combat always takes place in a region of space near a planet or other large object. The area is bounded and wraps around on itself so that when you leave one side of the combat zone, you appear on the other side. The screen always centers on the midpoint between your ship and the enemy vessel, so when one ship “wraps around” the screen, the view

will suddenly shift. At first this may be disorienting, but you will soon grow accustomed to the transitions.

Navigating Your Ship in Combat

Maneuvering your ship in combat is similar to travelling in interplanetary space. You rotate your ship in a desired direction and thrust forward. All of your ship commands (i.e. thrust, turn, fire, and special power use) may be triggered simultaneously.

Collision with Asteroids and Planets

Asteroids are large rocks which endlessly tumble through a solar system, trapped by the gravity of the star and its planets. Due to the sophistication of modern inertial dampeners, colliding with asteroids causes no damage, just a sudden change in course.

Impacting a planet is a different matter altogether. Your ship will be damaged severely, and potentially even be destroyed. Once again, **AVOID HITTING PLANETS.**

Ship Status Displays

The right side of the screen is broken into two Ship Status Displays, one for your enemy's ship, and one for your own vessel. In addition to showing who built the ship and the name of the captain that commands it, the status area displays key information which will be crucial to your success in combat.

Crew

The bar to the left side of the large ship icon shows the maximum and current crew levels. Each time a ship is damaged, green dots (crew) will disappear from the bar. When all the crew are gone, the ship is destroyed.

Batteries

To the right of the large ship icon is the battery charge bar which shows the current and maximum energy levels in the ship's batteries. Firing weapons or using a special power consumes energy (the amount depends on each ship's specific characteristics). Unlike crew, batteries recharge gradually over the course of the battle. The speed of energy regeneration varies from ship to ship, and is a significant factor in a ship's unique combat strategies. Ships with constant, fast energy renewal (like the Yehat Terminator) will want to close on their opponents and continuously blast away, while other vessels with slower energy regeneration (such as the Mycon Podship) will want to approach their enemy and attack, then retreat to accumulate a fresh supply of energy.

The Basics of Blasting

Getting your ship in the right position is crucial to firing. Therefore, you must keep several things in mind when confronting an opponent:

- The type and range of the weapon you're firing.
- The defensive capabilities of your opponent, both in defensive powers and evasive potential.
- The position of other objects, such as planets and asteroids, which may affect either craft, or the course of the fired weapon.

The computer opponent achieves its remarkable accuracy by firing not at your ship, but at where your ship is going to be.

The best way to learn how to shoot and maneuver is to repeatedly practice in SuperMelee, either against the computer opponent, or, preferably, with a friend.

Victory and Defeat

When you eliminate the last crew member from an enemy vessel, it is destroyed. If there are other ships in the enemy's task force, a new ship will warp in immediately. Since each ship's combat entry position is random, be prepared for immediate hostilities.

If one of your combat vessels is destroyed, you must pick another ship with which to re-enter the fray, unless your flagship was destroyed. **WHEN YOUR FLAGSHIP IS DESTROYED, THE GAME IS OVER.** In this unfortunate circumstance, you will be given the option to resume a saved game, start over from the beginning, or quit to DOS.

Running Away

If you are worried that one of your ships is about to be destroyed, you can choose to flee the battlefield. To run away while fighting with any ship, press the ESC key. Your ship comes to an immediate halt and begins an emergency warp-out maneuver. During this maneuver, you will be unable to control your vessel, but it will be vulnerable to enemy attack. The glow around your ship will pulse faster and faster until your vessel has generated enough force to speed out of the combat zone.

When you command an escort vessel to flee, you are prompted to select a new ship to fight with. The ship that fled will not be available for the remainder of the battle, but will return to the fleet when the fight is over. When you run away while using the flagship, you leave the battle altogether, taking your escort vessels with you.

Note: The emergency warp technology for escaping from combat has NOT been included on your ships at the very beginning of the game. However, this feature will become available early on in play.

Analyzing Enemy Wreckage

If you defeat all the enemy vessels in an attacking task force, you will scavenge and analyze the enemy wreckage. A scavenging report will tell you how much you have reclaimed.

APPENDIX I : KNOWN ALIEN RACES

Races in the Alliance of Free Stars

The first Alliance race to become aware of the Ur-Quan threat was the sophisticated, crystalline race, the Chenjesu. In 2098 their ultra-sensitive HyperWave receivers began recording strange broadcasts, unshielded and strong, from the direction of the Cygnus star cluster. Soon after, the Chenjesu listened as the Ur-Quan brutally conquered the first race they encountered, the Umgah. By 2111 the Spathi had also been subjugated and the Ilwrath, one of the Chenjesu's closest neighbors, was near defeat. The Chenjesu realized that they needed help fighting the Ur-Quan and their ever-growing armada of battle thralls.

The Chenjesu's long-standing mutual defense agreement with the Mmrnmhrm became the basis for the Alliance of Free Stars. Soon the Yehat and their foster-species, the uplifted Shofixti, entered the Alliance. Following Humanity's induction in 2115, the Ariloulaleelay and the Syreen (unofficially) followed suit, bringing the Alliance to its final configuration, seven alien races united against a common foe.



Chenjesu: This race is the only known form of silicon-based life-form to have achieved intelligence naturally. The Chenjesu are the oldest, most technologically advanced species in the Alliance, and while all members in the Alliance are officially equal, the Chenjesu are a bit more equal. Since this species evolved as a photo/chemo-vore (it derives its nourishment from light and ambient minerals) with no natural predators, the

Chenjesu are entirely non-aggressive, preferring calm philosophical discourse above all other activities.



Mmrmhrm: The Mmrmhrm's origin is mysterious. Less than a thousand years ago, the first Mmrmhrm awakened, alone, on the surface of a dark, airless moon. Looking up, the conical, segmented robot saw the huge factory-starship which had just finished manufacturing it by stripping the surface of the moon for raw materials and then refining these crude ores into final parts within its cavernous interior. Within a few years, the star system teemed with millions of intelligent, self-aware robots who called themselves the Mmrmhrm.

These non-hostile mechanical beings were assembled for some kind of mission by a distant alien race. When born/built, each Mmrmhrm awakens filled with knowledge and purpose, though to date the Mmrmhrm have not revealed the exact nature of their long-term mission. Within a century after the first Mmrmhrm was built, they had established peaceful relations with the nearby Chenjesu and colonized the adjacent stars in the Virginis constellation.

Yehat: The Yehat are a race of avian creatures who live their lives in the pursuit of honor for their clan, their Queen, and themselves through combat. Physically, these creatures resemble a 3 meter high hybrid between an old Earth pterosaur and a bumblebee. To succeed on their world, against larger, faster competitors, they evolved a complex, programmable neural control system – a thinking brain – which



allowed them to adapt to new situations with lightning speed.

Like Earthlings, the Yehat entered space without the assistance of a more advanced race. It is not surprising that they grant Earthlings such high honor and status for the same achievement.

The Yehat have great pride that they did not go through this uplift process, and that their culture is totally intact. In fact, the same ruling family has been leading the Yehat people for over 2000 years, dating back far beyond their Industrial Age.

Given their intensely martial society and advanced weapons technology, the Yehat became the backbone of the Alliance Starfleet.

Shofixti: A Shofixti resembles a large marsupial carnivore – sort of a killer shrew – who exhibits furious aggressive behavior contained within a strong ethical framework. When the Yehat first found them in 2075, the Shofixti were living in fortified mud castles in a feudal society similar to medieval Japan. The Yehat had such admiration for these feisty little warriors that they immediately “adopted” them and took responsibility for the Shofixti’s uplift, swearing that no “peace-loving” race would be allowed to dilute the Shofixti’s noble warlike tendencies. During the war the primary responsibility of the Shofixti starships was to act as advanced scouts, establishing mines, colonies, and fortifications throughout the stars.



Ariloulaleelay: Arilou (as individuals of this species are called) are pale, about 1.5 meters tall, and have large, childlike heads with dark, soulful eyes. Although Arilou never talk (communicating through direct telepathic link), they almost always wear a wide, innocent smile.



The Arilou may have visited Earth often in the past, especially in the period between 1950 and the year 2000, during which they are suspected of having been responsible for flying saucer sightings, cropfield circles, alien abductions and similar prankish behavior.

The Ariloulaleelay maintain great secrecy about themselves and their motivations. The location of their home-world, or even their native region of space, is unknown, as is much else about these beings. In fact, the very existence of the Ariloulaleelay was not certain until the year 2116 when they appeared without warning on Earth's moon and asked to be inducted into the Alliance.

Syreen: The Syreen people evolved on a paradise world in the Arianni constellation where they built a great artistic civilization in harmony with their environment. No citizen of Syrea suffered want or ignorance. Then, in 2035, a cataclysm of tectonic upheavals tore lava-filled chasms across the planet's surface and irrevocably poisoned their atmosphere. The disaster killed off almost all the Syreen population – only those in the Syreen Space Patrol were untouched. The male population, who were rare in the Patrol, were virtually eliminated.

The Syreen Space Patrol collected what few survivors could be found on the surface and transformed their many orbital space platforms into huge starships.

In the following decades before the War, the Syreen became wandering space-gypsies, navigating their fleet of Habitats through the starways, searching for a new planet of such surpassing beauty that it would forever wash away the pain of losing Syrea, their Eden.

The Syreen became unofficial members of the Alliance in 2120, after suffering repeated Ur-Quan attacks on their fleets of slow-moving Habitats. Adapting their remaining Patrol vessels for combat, the Syreen became a potent force in the fight against the Ur-Quan. The single greatest weakness of the Syreen star fleet, its severe shortage of trained crew-members, was alleviated by Syreen scientists who developed a psionic amplifier which could compel even the most hostile alien to serve a Syreen ship captain with perfect faithfulness. Crews on board Syreen ships became a surreal pastiche of alien races, with Ilwrath, VUX, Spathi and others working dutifully side by side with human volunteers under the command of beautiful Syreen officers.



Races in the Ur-Quan Hierarchy

The history of the Ur-Quan is largely unknown, save that they are an old race who have travelled the galaxy for thousands of years with a single motive: To find intelligent life and enslave it. Most Xeno-psychologists agree that the Ur-Quan behavior indicates they suffered some kind of severe trauma, and are neurotically acting out their need to control everything by enslaving any intelligent species they meet. Most starship commanders who have faced the Ur-Quan in combat think the Ur-Quan attack and enslave simply because they are evil, hostile creatures who should be destroyed.

The organization of the Ur-Quan Hierarchy is simple and immutable: All alien races are inferior to the Ur-Quan. Battle Thralls, those other races who fight for the Ur-Quan, are granted the next highest status, and are

permitted to maintain a small amount of autonomy. All other independent species are simply known as prey.



Ur-Quan: Physically, Ur-Quan resemble the predatory caterpillar native to Earth's Hawaiian Islands, only grown to over ten meters in length. The Ur-Quan equivalent of a face is rich in sensory organs, and its expressions are varied and horrific. Aboard ship, these creatures cling to webbed ceilings with their back legs, dangling down over their controls and their slave-crew like hungry spiders.

Ur-Quan are extremely territorial and aggressive, having evolved as non-social, hunter-killers. Their territorial instincts are so strong that only one Ur-Quan is present on each Dreadnought. When Ur-Quan meet, they keep several meters between themselves, lest their instincts drive them to engage in an unarmed battle to the death. A simple, linear dominance structure dictates power within the Ur-Quan species. Each member of the species has a number, indicating its relative power and authority. Ur-Quan Master #1 is the ultimate lord of the entire Hierarchy.

The Ur-Quan are unwilling to communicate directly with other species because to do so would be demeaning. Therefore, when giving orders or interrogating enemies, the Ur-Quan use "Talking Pets," large-brained, frog-like creatures which are non-sentient, but possess the telepathic/empathic ability to translate all languages.

Mycon: The Mycons are neither plant nor animal, having evolved from something more closely resembling an ambulatory fungus. Mycons are asexual and reproduce by budding their own flesh into a separate offspring. They exchange genetic material by exhaling and inhaling DNA-rich

spores. Mycons are most comfortable in a hellish environment of hot rock and poisonous vapors which would kill most other species in seconds. Culturally, the Mycon are baffling. They appear to be born adult, instantly able to assume responsibilities. In addition, all Mycons occasionally undergo temporary but dramatic personality transformation, as though they were “possessed” by a different Mycon personality.

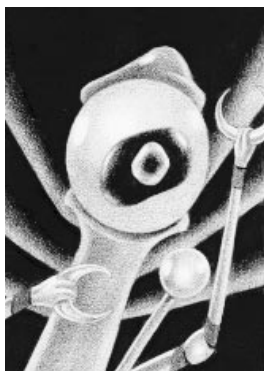
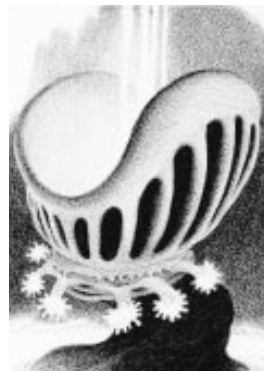

Spathi: The Spathi are all abject cowards and have built quite a successful civilization around this basic characteristic. The Spathi physique is slight and soft, with the vital organs being covered by a hard shell surface. Spathi have large, humanoid eyes atop stiff thick stalks that protrude from their central body mass at odd angles. When alarmed Spathi ooze copious amounts of unpleasant fluid from their pores.

It is somewhat confusing why the Spathi chose to fight with the Ur-Quan, since they certainly didn't fight very hard against them (having surrendered after less than 6 hours of combat).

Umgah: The Umgah are blobbish creatures consisting of four main attributes; eyes, mouths, tentacles and a strong sense of humor. The Umgah make use of biological forms in their technology and must often rely on biomechanical hybridization.

The Umgah prefer warm, moist subterranean dwellings, sheathing the interior of their ships with a thick, wet skin, and suffer from agoraphobia – the fear



of open spaces.

Before they were enslaved by the Ur-Quan, the Umgah culture was relatively peaceful, content to expand slowly through the surrounding Orionis constellation. The most serious conflicts caused by the Umgah are the result of their incessant practical jokes, such as clogging a fleet of Spathi Eluders' life-support systems with fast-growing foul-smelling goo.

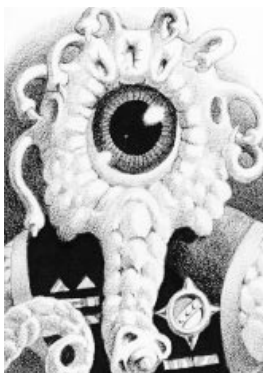

VUX: The VUX are bipedal, and would be considered humanoid were it not for their heads, which look like a tragic combination of a squid and a banana slug. The VUX are very sensitive about their looks. Indeed, in the VUX culture, physical appearance is of tantamount importance, and the VUX spend a great deal of their time on clothing, jewelry and useless finery.

The VUX's repulsiveness to most other races is matched by their technological achievement in linguistic translation devices. This combination led to the unfortunate incident in 2126, when the Earthling Cruiser *Miwok* made first contact with the VUX near the Beta Luyten star system. The *Miwok's* Captain Rand, upon first seeing the VUX commander on his view screen, remarked to his officers, "That's the ugliest freak-face I've ever seen!" Rand was unaware that his every word was being relayed to the VUX captian with perfect clarity. This grievous insult, and the subsequent ill-will between Earth and the VUX delayed the VUX's entry into the Alliance long enough for the Ur-Quan to enslave them.

Androsynth: These human clones established a fledgling colony in the Vulpecular constellation after fleeing from Earth in the year 2085. During the following three decades, the Androsynths focused their energies on

reproduction and armament. The Androsynths were totally unaware of the Ur-Quan invasion until the aliens were on top of them, capturing their home star system in a few short weeks of intense interplanetary combat. Androsynths now fight for the Ur-Quan and many Earthlings fear that should the Alliance lose the War with the Ur-Quan, the Androsynth's hostility toward Humanity could result in great suffering for Earth.



Ilwrath: Before the arrival of the Ur-Quan, these violent, religious insectoids were of little consequence to their neighbors, the Chenjesu and the Mmrmhrm, because they possessed little in the way of advanced technology or raw resources. However, when the Ur-Quan conquered their species, the spiderish Ilwrath became dangerous indeed. Now, with modern weapons and drive systems, the Ilwrath revel in their opportunities to deceive and destroy other forms of life, as is required by their twin gods of evil, Dogar and Kazon.

APPENDIX II: PLAY TIPS FOR STAR CONTROL II

Star Control II is mostly self-configuring, and most players will never have to do more than type the program name. However, in a few circumstances, you may have to adjust either your computer system or the program.

Maximizing Available Memory

If you receive the error message, "Not enough memory to play Star Control II.", you will need to free up memory on your computer. Some simple ways to do this include:

- Installing the game on and playing from your hard drive.
- Removing TSR programs or unnecessary device drivers from your AUTOEXEC.BAT and CONFIG.SYS files. **Star Control II** does not use a mouse, so removing your mouse driver (if your system loads one) would be a good first step. In general, the only such programs you will need are hard disk performance programs, such as disk caches or automatic file compression utilities.

Enhancing Game Performance

Star Control II is a complex, multi-tasking program which plays all sound and music by mixing up to 8 digital channels in real time. Consequently, if you are running on a slower machine, you may experience less than optimal performance, particularly if you are running internal speaker sound, which has the most significant impact on performance.

To improve the game's performance you can:

- Buy a faster computer.
- If you are running with internal speaker sound, either purchase one of the supported sound boards, which do not hamper perfor

mance as much and sound lots better, or shut down sound and music altogether (see Specifying Sound Card on the Command Line, for details).

Solving Possible Conflicts with TSRs

Some TSRs and device drivers do not cooperate with the **Star Control II** program. The most common such problems occur on 386 machines with older, extended memory managers. The symptoms include system lock-up when the program first fires up, or INCREDIBLY slow performance. To fix these problems you can:

- Configure the extended memory manager NOT to emulate expanded memory.
- Remove or replace the extended memory manager.
- Shut down sound and music altogether (see Specifying Sound Card on the Command Line, below, for details).

Known Conflicts

Conflict: Extended Memory Manager (only in rare instances)

Symptom: Extremely slow performance and in rare cases, system halts.

Solution: Modify config.sys or autoexec.bat files to remove memory manager.

Conflict: Gravis Ultrasound board in combination with Soundblaster or Roland sound boards.

Symptom: System halts immediately when game is run.

Solution: Remove all sound boards except Gravis Ultrasound, or remove Gravis Ultrasound.

Specifying Sound Card on the Command Line

Star Control II automatically detects supported sound cards (inside your computer) when you load the program. However, there are some peripheral sound devices which are not detected. For these devices, you will

have to add a code to the command line: STARCON2 /s:DEVICENAME
where DEVICENAME is one of the following:

Code	Sound Device
DISNEY1	Disney Sound Source on parallel port #1.
DISNEY2	Disney Sound Source on parallel port #2.
LPT1	Covox Speech Thing or other sound peripheral on parallel port #1.
LPT2	Covox Speech Thing or other sound peripheral on parallel port #2.

If you want to specify explicitly your sound board, follow the above convention with one of the following codes:

Code	Sound Device
INTERNAL	Internal speaker
ADLIB	An Adlib sound board.
SBLASTER	A Soundblaster.
PAS	A Pro Audio Spectrum.
SM2	A Sound Master II
ASC	An ASC Media Master
MICRO	Microsoft Windows
GRAVIS	Gravis Ultrasound

If you want NO sound, use the code SILENT.

Loading Problems

If you load Star Control II and experience the following:

- The game doesn't start properly,
 - You see a "Not Enough RAM" error message,
 - Freezes or erratic game play,
- see the Booting Clean section.

Garbled Graphics or Blank Screen

Star Control II supports VGA or MCGA graphics only. If your computer does not have these graphic cards and a color monitor, this game will not work on your system. If you do have these and still experience a blank screen or garbled graphics, see the Booting Clean section below.

Graphic Adapter Fix

Certain computers, (i.e. Tandy 4850 EP) have unusual video hardware. Therefore, colors in the game might not look quite right. If you experience this problem, try running the game as **STARCON2 /g:BIOS**. This will force the program to update the color palette using the BIOS functions. Since most BIOS calls are far slower than custom routines, a minor performance penalty may be noticed when using this option.

Note: Any command line additions can only be made if you are launching the game without using the front-end menu.

Booting Clean

The easiest way to resolve loading problems, DOS conflicts, memory problems, erratic game play, etc., is to copy the games to your hard drive, and boot your computer with a “boot disk” each time you wish to play. A boot disk is a “clean” DOS system disk that will maximize use of memory.

If you are in Windows 3.1, you need to exit Windows to get back to DOS. From the File pull-down menu, choose “Exit Windows”. A dialog box will appear mid-screen. Click on “OK”. You are now in DOS.

If you are in Windows '95, go to DOS by clicking on “Start,” then “Shut Down and Restart the Computer in MS-DOS Mode”.

First, copy **Star Control II** to your hard drive.

- 1 At the DOS prompt, type C: <Enter>
- 2 At the DOS prompt, type CD\ <Enter>
- 3 Type MD STARCON2 <Enter>
- 4 Copy the **Star Control II** files to your hard drive. At the DOS prompt, type COPY D:\STARCON\STARCON2*. * C:\STARCON2 <Enter>

Note: If you enter this command and receive the message, "Invalid Drive Specification," your CD-ROM drive is not properly set up for use in MS-DOS mode. Contact your computer retailer or manufacturer for assistance.

Star Control II is now copied to your hard drive.

Creating a Boot Disk

- 1 Make sure you have a high-density diskette on hand that will fit into drive A:
- 2 At the DOS prompt, type FORMAT A:/S <Enter>
You will be prompted to insert your diskette into drive A:. When the computer asks you to enter a label name, press <Enter>. When the computer asks if you want to format another diskette, answer NO.
- 3 At the DOS prompt, type A: <Enter>
- 4 At the A: prompt, type COPY C:\CONFIG.SYS <Enter>
- 5 At the A: prompt, type COPY C:\AUTOEXEC.BAT <Enter>
- 6 At the A: prompt, type EDIT CONFIG.SYS <Enter>

Note: PC-DOS users may have to type E CONFIG.SYS <Enter>

The editing screen display is blue with several lines of white text. Each line of text is one DOS command.

7 Only some of these lines are necessary for your game to run properly. The lines we need can usually be left just as they are. Keep the following lines intact:

- The line with HIMEM.SYS (or any other upper memory manager)
- The line with EMM386.EXE (or any other expanded memory manager)
- Any lines pertaining to your Sound Card
- Any lines necessary to the normal operation of your computer

For all other lines, move the cursor to the left edge of each line and type REM <Spacebar>.

8 Once you have finished editing the CONFIG.SYS file, press <ALT+F> then <S> to save the file. PC-DOS users will need to press the <F3> key instead.

9 Press <ALT+f> and <X> to exit the editor.

10 At the A: prompt, type EDIT AUTOEXEC.BAT <Enter>

Note: PC-DOS users may have to type E AUTOEXEC.BAT <Enter>

11 Keep the following lines intact:

- @ECHO OFF
- PROMPT \$P\$G
- the PATH line
- Any lines pertaining to your Sound Card
- Any lines necessary to the normal operation of your computer

For all other lines, move the cursor to the left edge of each line and type REM <Spacebar>.

12 Follow steps 8 and 9 above to save the file and exit the editor.

The boot disk is now ready for use with the **Star Control Collection**.

To Play Star Control II, insert your boot disk into your A: drive and either



turn on or reboot your computer. At the A: prompt, type C: <Enter>. Type CDSTARCON2 <Enter>, then STARCON2 <Enter> to launch the game. When you finish playing, remove the boot disk from the A: drive and either turn off or reboot your machine.

Technical Support (408) 296-8400

If you still need help with this – or any other – Accolade product, please give us a call between the hours of 8 am and 5 pm (Pacific Standard Time). Be sure you are at your computer when you call. You can also write us at:

Accolade
Attention: Customer Support
5300 Stevens Creek Blvd. #500
San Jose, CA 95129

Online Support

For your convenience and support, Accolade maintains a Web site at <http://www.accolade.com>. For technical support and information, email us at techhelp@accolade.com

Accolade is also on CompuServe and America Online. Members of CompuServe can email us at 76004,2132 or type GO GAMAPUB and leave a message for us in the Accolade section. Members of America Online can go to our area at Keyword: Accolade, or send email to "Accolade".

APPENDIX III: INSTRUCTIONS FOR SUPERMELEE

SuperMelee is pure Star Control combat. In this bonus game you can fight against the computer opponent, or even better, battle another human player. SuperMelee battles are fought between two rival teams, composed of up to 14 ships, using any combination of the 25 alien vessels from Star Control and Star Control II.

If you have never fought a Star Control space battle, SuperMelee is the necessary training ground where you will learn to survive in the hostile starways of **Star Control II**. You can begin by fighting weak opponents, learning the ins and outs of tactical combat. Then, as your skills improve, you can take on more cunning foes and begin to explore the unique stratagems for each ship-to-ship combination.

The experienced Star Control player will relish the 11 new ship types, the multiplicity of ship battle combinations, and the ability to devise his or her own SuperMelee teams.

Starting SuperMelee

To play SuperMelee:

- 1 Turn on your computer.
- 2 Get to the point in DOS where you would normally launch the game. If you play from the CD, choose SuperMelee from the Star Control menu, and ignore steps 3 & 4.
- 3 Change to the directory that contains the game. For example, if you installed the game in a subdirectory named STARCON2, type **CD STARCON2** and press **Enter**.
- 4 Now type the file name, **MELEE**, and press **Enter** again. Note that MELEE.EXE has the same command line options for sound as

STARCON2.EXE (see **Specifying Sound Card on the Command Line**, for details.)

Note: The Melee program tries to run at the same speed on all computers. If you would like to unleash your computer's power and play at maximum speed, add /frenzy on the command line after Melee.

The SuperMelee Main Screen

The SuperMelee Main Screen includes three regions: The Team Display, which shows the ships in each team as well as their name; the Game Settings, which records the manner you have configured the game; and the Main Menu, which lists the general commands at your disposal. As a convenience, SuperMelee always remembers most recently used teams and settings, and automatically loads these for you whenever you start the game.

Creating a SuperMelee Team

To create a SuperMelee Team:

- 1 First highlight **EDIT** on the Main Menu and press **Enter**.
- 2 Using the **Arrow** keys, move the cursor to the slot where you want to add a ship and press **Enter**. The highlight will now move to the list of available ships.

Note: If you place the cursor on a slot which already contains a ship, that ship will be replaced with your new choice.

- 3 Using the **Arrow** keys, move the highlight in the ship list. Only two ships are shown at one time. To scroll the entire list, move the highlight

up or down. The list shows not only the names of the ships, but their values as well. Ship values are useful when two or more players want to compose different teams with the same overall strength. When you have highlighted the ship you want to add to your team, press **Enter** and the ship will appear in the Team Display region. The cursor now returns to the Team Display region.

4 Continue placing as many ships as you like on both teams by repeating steps 2 and 3. Notice that as you add and remove ships from each team, the total team value changes to reflect your modifications.

5 If you want to remove a ship from a team, highlight the ship in the Team Display Region and then press the **DEL** key.

6 To change the name of a team, move the cursor to the name, which will then highlight. Use the **Backspace** and **Delete** keys to remove the old name, then type in the new team name. When you are finished naming a team, press **Enter**, or just move the cursor up or down off the team name using the **Arrow** keys.

7 When you are done creating your team, press the **Spacebar** to return to the Main SuperMelee Menu.

Game Settings

The current game settings for both Player #1 and Player #2 are shown in the Game Settings Display, just above the Main SuperMelee Menu. When you choose **SETTINGS** from the Main SuperMelee Menu, the cursor will move to the Game Settings Window. To change a setting, move the highlight to the desired setting and press **Enter**.

When you are done changing the game's settings, press the **Spacebar** or **Button #2** to return to the Main SuperMelee Menu.

Who Controls Each Team

In SuperMelee you can play against a human opponent (the most fun), or

against a computer controlled foe. To change who controls a team, highlight the setting and press **Enter** or **Button #1**. You can set both teams to have computer control. In this case they will fight a totally automatic series of battles against each other during which you can study their techniques.

Input Device

You can play SuperMelee with joysticks, keyboard, or a combination of both. To reconfigure the keyboard configuration, run the separate keyboard configuration program KEYS.EXE. For consistency, the configuration you set for SuperMelee will also be used in **Star Control II**.

Note: Any keyboard configuration other than the default will only be saved if you are playing from your hard drive. If you use the KEYS command and are playing from the CD-ROM, your new configuration will not be saved.

Computer Opponent's Skill Level

In SuperMelee you can set the computer opponent's skill level to accommodate beginner, intermediate or advanced players. To cycle through the skill levels, move the highlight to the skill description for the team you want to change and press Return. The skill levels are:

- **Standard (default setting):** The standard computer opponent never uses its special power, nor does it shoot very accurately. This setting is suitable only for beginning players or young children.
- **Good:** At this setting the opponent shoots more accurately and begins to use its special power, though not necessarily at the best time or place.
- **Awesome:** Playing SuperMelee against a computer opponent set to Awesome should remain a challenge for quite some time. At this skill level, the computer only shoots when it is sure it will hit you if

you continue along your present course. The computer now uses its special power at maximum effectiveness.

Leaving Settings Menu

When you have established your desired settings, press the **Spacebar** to return to the main SuperMelee Command Menu.

Saving and Loading SuperMelee Teams

To save a team, highlight **SAVE** from the Main Menu and press **Enter**. Type in the name of your team (8 letters maximum) and press **Enter**. To load a team, select **LOAD** from the Main Menu and press **Enter**. Highlight the team you want to play using the **Arrow** keys and press **Enter** again.

Fighting in Melee

Now that you've selected your settings and created your teams, you're ready for a game of SuperMelee. From the SuperMelee Main Menu, select **MELEE**. You will now see a subscreen for each team in turn.

Picking Ships

Each player now picks his first ship to fight with. If you are playing against a computer opponent, it will do so automatically. To pick a ship, move the flashing cursor over the desired ship and press **Enter**. If you want the next ship to be chosen randomly, highlight the **"?"** and then press **Enter**.

Fighting a Battle

Combat in SuperMelee is identical to combat in Star Control II, except that you cannot flee from battle. When a ship is destroyed, the ship selection menu will appear, allowing you or your opponent to select the next ship to fight.

Winning SuperMelee

When all of one player's ships are destroyed, the Melee is over. Each player's menu will then appear, allowing the winner to gloat over his many victories. This final display also shows the winner's remaining ship points which indicate the margin of victory. Use the following guidelines to determine the quality of the victory:

Winner's Remaining

Ship Points

5%

10%

25%

50%

75% and up

Quality of Victory

By the skin of your teeth.

A good, close game.

A serious thumpin'.

Totally Cree-mated!

Who are you playing with – a moon rock?

Remember, if you get "Cree-mated", there's always the best-2-out-of-3!

Replaying Melee with the Same Teams

To begin another SuperMelee with the same teams, just press any key after the ship selection screen has been displayed.

Returning to the Team Edit Screen

After a SuperMelee game is over, or at any time during play, you can quit the battle and return to the SuperMelee Main Screen by pressing **F10**, and then confirming your exit by pressing **F1**.

APPENDIX IV: KEYBOARD CONFIGURATION UTILITY

The Keyboard Configuration Utility – Keys.exe – lets you reconfigure the keys you'll use as the control keys in **Star Control II**.

- 1 Boot your computer as normal
- 2 Type CD \Starcon2 and press Enter.
- 3 Type keys and press Enter. The following options will appear onscreen:
 - F1** Select a new keyboard layout
 - F2** Experiment with different keyboard combinations
 - F3** Information on keyboard configuration
 - F10** Quit to DOS

When you press **F1** to change the keyboard layout, you are given the option of changing the Player 1 or Player 2 controls. Press the corresponding function key to select your option.

After you've selected your keys, you'll be given the option to redo them. Press **N** to keep them, or press **Y** to change them.

To save the new keyboard configurations, press **F7** at the Control Keys Menu.

APPENDIX V: COMBAT VESSEL DESCRIPTIONS

Following are brief descriptions of the combat capabilities of all of the ships in **Star Control** and **Star Control II**. These descriptions are intended to give an overview of the ships' attributes and special powers, as well as a few tactical combat tips.

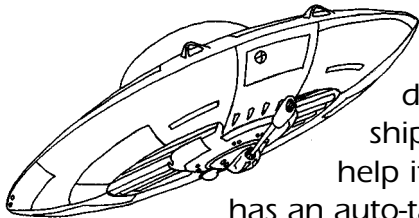

Ariloulaleelay Skiff – An Arilou Skiff, when flown skillfully, can be one of the most effective spacecraft. Its speed and inertia-less drive make it the most maneuverable of all ships, and its special ability to teleport can help it escape from fatal situations. The Arilou Skiff has an auto-targeting, swivel-mounted, short-range laser that pumps out damage quickly. Unfortunately, the Arilou ship can

sustain only a minimal amount of damage itself. A successful captain will use the teleport function, as well as an opponent's inertia, to move in quickly along the rear or flank of the enemy ship, unload from a full store of energy, and then fly or teleport quickly away to recharge.

Chenjesu Broodhome – The main weapon of the Chenjesu, the photon crystal shard, is versatile for both offense and defense. As long as the fire button is pressed, the shard continues on its way. If you hit an enemy with the whole crystal, it does a great deal of damage. If the crystal misses, release the fire button while it is still near the enemy ship and the shard will explode into smaller pieces. Since the crystals do not harm the Chenjesu, they can be exploded at point blank range to create a kind of ack-ack.

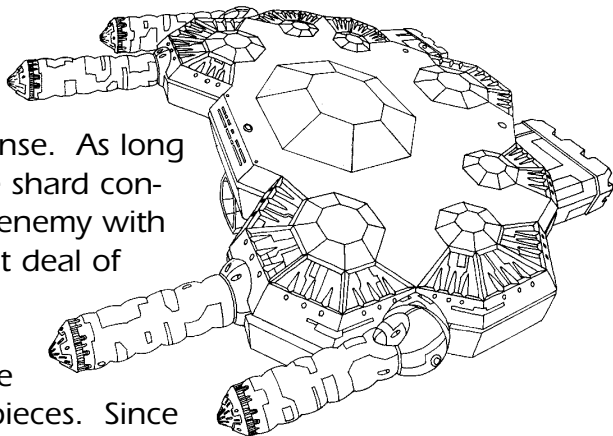

One powerful ability of the Chenjesu is to launch self-directed DOGIs (De-energizing Offensive Guided Interceptor). These little drones can steal the energy from ships, or just pester the enemy until they are ready to give up. The best strategy for a Chenjesu is to keep a good distance between itself and the enemy ship.

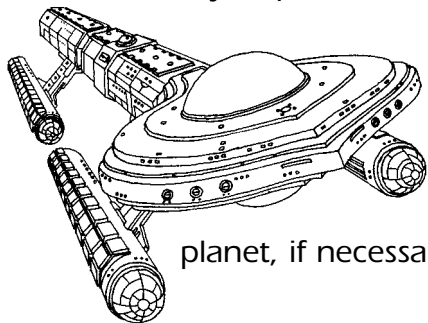

Earthling Cruiser – The Earthling Cruiser is a vessel designed primarily for hit-and-run long-range attacks. Stay away from the enemy ship, and fire your seeking nukes constantly! Use a Gravity Whip off of the planet, if necessary to keep your distance, but be careful not to

collide with the planet. The only reason ever to get close to an enemy vessel is to make an honorable, point-defense laser “coup de grace”, to eliminate the opponent’s last crew member.

Mmrmhmr Xform – The X-form is actually two ships in one. Its special power allows it to transform from one form into the other. The Y-Wing form of this ship is fast but not very maneuverable, and it fires long range homing missiles that do only a small amount of damage. The X-Wing form is slow, but has good turning capability, and fires a powerful double-lance, convergent laser. One very effective way to take advantage of this ship is to stay mostly in the faster Y-wing form, transforming into the X-Wing form only to make quick turns or ward off would-be attackers when they get too close.

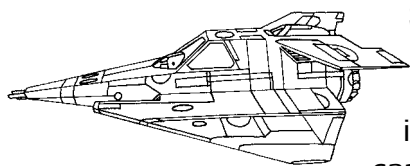
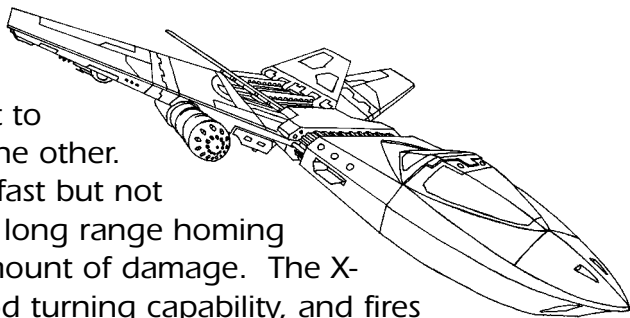

Shofixti Scout – Shofixti Scout ships are small and very quick. They have a limited number of crew, and a relatively weak forward firing gun with a moderate range. The special capability of this ship is that it can detonate itself like a big bomb, and cause great damage to an opponent’s ship. Of course, this requires that the Shofixti ship get itself close enough before detonating.

Shofixti captains who are patient may find that their little gun can be quite effective when fighting slow, or short-ranged enemy vessels.

Syreen Penetrator – This space vessel has the unique potential to leave a battle much stronger than it enters it. The goal of a Syreen ship is

always to get close to the opposing ship and use the Syreen call. This causes the enemy crew from the opponent's craft to jump ship and drift through space towards the Syreen ship. The Syreen can then pick them up and use them as her own crew. One very effective trick is to use the Syreen call and fire simultaneously. This way, when your opponent has only one or two crew members left, the Syreen can destroy them before they have a chance to pick any of the crew back up again.

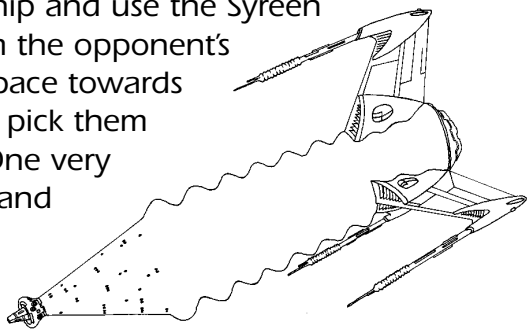

Yehat Terminator – The powerful and direct Yehat Terminator is the earliest of all Star Control ships. The ship is equipped with extremely powerful medium-range dual cannons, as well as a shield that, when activated, protects it from any weapon. Avoid the temptation of exhausting all of your energy with your guns, saving some for your shields. Also remember that energy generation on the Yehat ship is not sufficient to maintain constant shielding. Lastly, since Yehats are not particularly fast, they can often benefit from a 'Gravity Whip' from the planet. This allows them to strafe an opponent as they go sailing past.

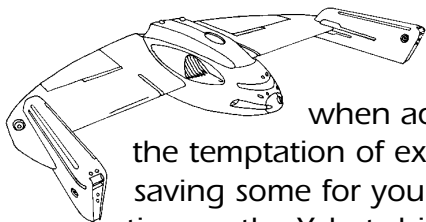

Androsynth Guardian – The Androsynth vessel is normally very slow, and its weapon fires auto-homing molecular acid bubbles. These tend to be most effective when fired en masse to create a dense cloud of bubbles that can serve as a haven for the Androsynth ship, or to create a cloud of bubbles in the opponent's path. The Guardian can transform itself into a blazing

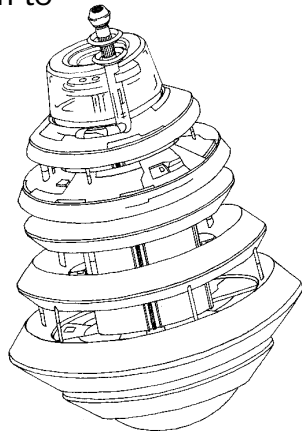

comet-like ball of energy. When it does this it travels at high speed, until all of its energy is used up. When the Androsynth is in this comet-like “Blazer” form, it can ram an opponent’s ship and do a large amount of damage. Another use of the Blazer form is for escape.

Ilwrath Avenger – The Ilwrath ships are only moderately powerful because they are not very fast, and their weapon is only effective at short range. In order to compensate for their weapon’s shortcomings, the Ilwrath ship has a special cloaking capability.

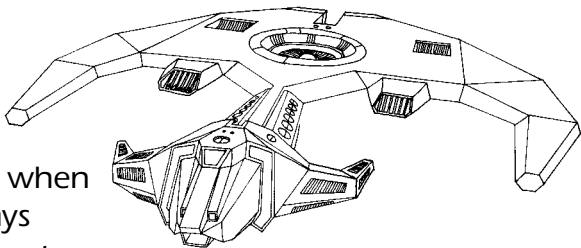

Learn where the Ilwrath Avenger is when it is invisible. Since the screen always centers on the midpoint between the two ships, the Ilwrath is always diagonally opposite its opponent. When your enemy gets near the center of the screen, you must be there too. So open fire, literally! Be aware that when you uncloak by firing your hellblast, your ship is automatically oriented to point at your opponent’s ship. If your enemy has maneuvered around behind you, you can turn around instantly by cloaking and immediately firing your hellblast.

Mycon Podship – This extremely slow ship can fire a strange homing weapon made of semi-sentient energy plasma that dissipates after it is launched and does a huge amount of damage if it hits the opponent. The Mycon ship can also use its energy to regenerate crew that have been lost.

Against most ships, the Mycon Podship is a dead duck if it sits still. Once it gets moving, (a good Gravity Whip will do), its commander can fire a plasma torpedo now and then, and regenerate any damage that comes his/her way. However, to give yourself time to respond to an onrushing

celestial body, avoid diagonal whip trajectories.

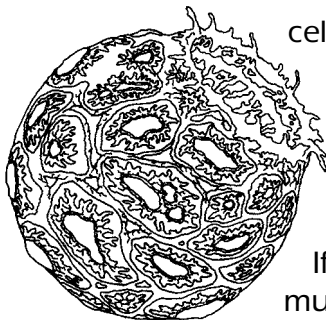

One of the most serious threats to the Mycon is its own weapon, the expanding plasma cloud. Fast ships, like the Arilou, Shofixti, or Slylandro, will try to direct the plasma weapon back upon the Mycon. If the Mycon is moving at or beyond its normal maximum velocity, it can overrun its own weapon immediately after launch, suffering grievous casualties. Solution:

shoot backwards.

Spathi Eluder (previously known as “the Discriminator”) – The Spathi ship is very fast and maneuverable with a moderately ranged and relatively weak forward firing gun. This ship is most dangerous when running from the enemy and launching BUTT (Backward Utilized Tracking Torpedo) missiles directly into its pursuer’s path. The Spathi commander’s main job is to entice his opponent into chasing him. Taunts and jeers work well. Another effective strategy for a Spathi commander is to circle his opponent’s ship, just out of range, bobbing in to launch BUTT missiles, and then out again.

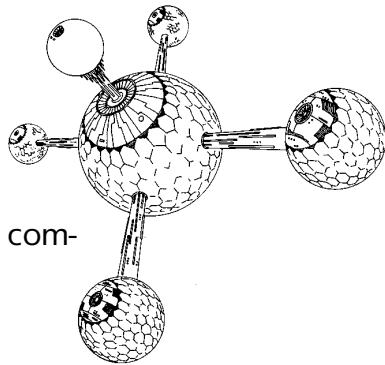

The otherwise ineffectual forward guns can become quite deadly with practice. If you need to kill only a few more crew for a victory, as when fighting an undamaged Arilou, don’t shoot your wad in a single facing. Instead, rotate as you fire to increase your chance of a lucky hit.

Umgh Drone – The Umgh Drone can defeat any other ship, given just a few seconds at close range. A favorite Umgh tactic is to zip backwards

right up next to its enemy. If the anti-matter cone is up through the maneuver, there is a chance of it grazing the enemy as you zip past for a few bonus points of damage – especially important against the Arilou. Another way to use the retro-movement is to thrust at the same time you zip backwards. This results in a jerky, half-speed maneuver which opponents often find difficult to deal with.

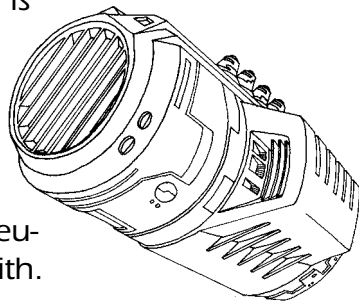

The Umgah's anti-matter cone also makes an effective shield against most incoming missiles. Notable exceptions are the Chenjesu's whole photon crystal and the Ur-Quan's fusion blast, which pass through the conical field unharmed. The Umgah receives all its power in one big whack after a considerable delay. Each time the Umgah uses its anti-matter cone, this delay is reset to maximum. So if you keep the cone up, you will never regain fuel.

VUX Intruder – Rather than building a faster ship, the VUX have taken the approach of slowing the other ships down. They do this by means of homing limpets which cling to the hull of an enemy ship, making it less and less maneuverable. In addition to this, the VUX ship comes equipped with a very powerful medium-range laser, and a large store of energy to power it.

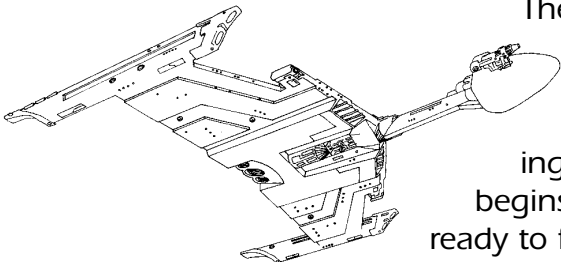

The VUX is one of the slowest and least maneuverable ships in the game. Helping to offset this, the Intruder has the advantage of always appearing near an enemy vessel when combat begins. The VUX commander must be ready to fire instantly, and make course adjust-

ments to keep his laser on target. If the enemy escapes and possesses any long or intermediate range weapons, the VUX must immediately seek out a planet and engage in a Gravity Whip. If the enemy launches a seeking weapon, don't forget to shoot at it as it approaches. When the VUX nears its target, it should slow by rotating to face the enemy and thrusting. Never engage your enemy unless you have lots of fuel!

To make effective use of your limpets, deploy them in a curtain, then turn and thrust ahead of where your enemy must flee to avoid them. When the enemy is really gunked-up, and you are fully recharged, use your laser to blast the enemy ship's hull. Remember, though the Yehat's shield is proof against your laser, your limpets pass through its defenses unaffected.

Ur-Quan Dreadnought – Most experienced players would probably say that either the Ur-Quan Dreadnought or the Kohr-Ah Marauder is the most powerful ship in the game. The Ur-Quan has an immensely powerful medium-long range weapon that fires rapid fusion plasma blasts. It also has the capability of launching pairs of autonomous, laser-equipped fighters. Remember that each fighter represents a departing crew member. So if you are wounded to start out with, don't send off all but the last few of your crew and risk defeat through a single lucky enemy shot. Also, fighters expire if you don't let them return to your ship. Avoid high speed chases or your fighters will be left far behind. Use fighters at short range and in conjunction with your main weapon. For best results, chase an opponent in one direction while you head off in the opposite direction to meet him as he wraps around.

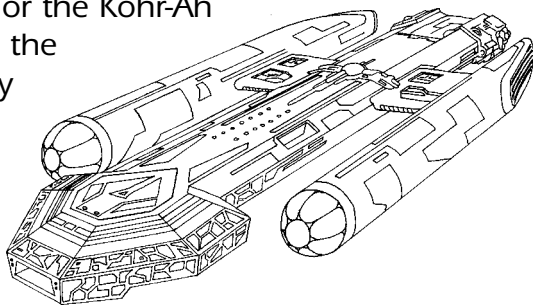

Kohr-Ah Marauder – The Kohr-Ah ship is one of the few ships that is a good match for an Ur-Quan Dreadnought. The two ships are comparable in speed, maneuverability, crew, and energy regeneration. However,

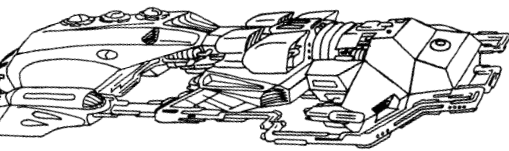

instead of firing plasma blasts, the Kohr-Ah vessel fires missiles which continue to move away from the ship until the Fire Button is released. Once the Fire Button is released, these spinning, metal blade-

disks remain where they are placed. When an enemy vessel draws near, it tracks on the vessel and closes with it. A Kohr-Ah commander will often first lay down a defensive wall of blades around his ship, then litter an opponent's path with the spinning weapons. Only eight blades may be present on the screen at any given time. When a ninth is fired, the first one disappears.

The other capability of the Kohr-Ah ship is known by the other alien races as "the Fiery Ring of Inevitable and Eternal Destruction" or F.R.I.E.D. This is actually an expanding ring of super-heated gases that can be used both for defense and close range offense. When facing the Ur-Quan, the Kohr-Ah is better off staying farther away, and the Ur-Quan is better off closing.

Utwig Jugger – This slow, tubby craft is only a moderately powerful ship. However, it is particularly well suited to facing the Kohr-Ah and the Mycon. The Utwig, in addition to its forward facing, wide area guns, has the special capability of shielding itself. This shielding, however, uses up energy which cannot be regenerated, so the trick for Utwig commanders is to acquire more than they use. Against ships that fire rapidly and continually, the Utwig commander can find himself

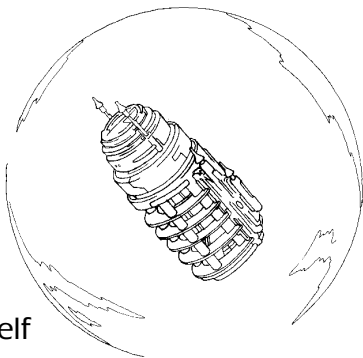

being tricked into shielding unnecessarily and wasting his energy. The best strategy for the Utwig is to close with the opponent's ship using a Gravity Whip when necessary, and time the shielding to catch any incoming shots. DOG1's from the Chenjesu are an Utwig commander's greatest fear, as they quickly turn his ship into a sitting duck.

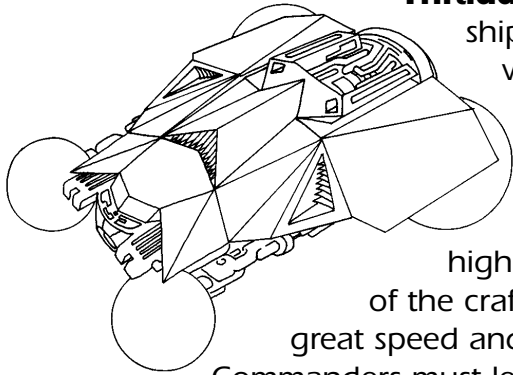

Thraddash Torch – The Torch is a difficult ship to master, but can be quite potent when it is flown well. The normal weapon of this ship is a simple long range weapon that does a small amount of damage. The special capability of this ship is to eject ultra high pressure bursts of plasma out the rear of the craft. These propel the ship forward at great speed and act as an effective turbo boost.

Commanders must learn to use this as their primary means of propulsion rather than their engines, which actually slow the vessel down. By using the rear 'Torch', commanders can stay far away from shorter range ships, and hit enemies with its long range weapon. When these Torch bursts are laid down in a wall in the path of an opponent that is moving a lot, they can be a powerful offense.

These bursts can also be used defensively to block incoming shots. This technique requires the Torch captain to keep the rear of the ship facing the opponent whenever it is not advantageous to be firing.

Supox Blade – The Supox Blade is another effective ship. In combat situations, any ship that can get another ship to chase it is in an advantageous position. The Supox, with its ability to reverse direction, is well suited to this strategy. This is done by approaching a ship head-on. As soon

as that ship is in range, the Supox reverses the direction of its thrust and flies backwards, shooting at the ship that is all of a sudden following it. To travel backwards, press the **Thrust** key and the **Special** key simultaneously. Another capability of the Supox ship is to move laterally. To perform this maneuver, press the **Special** key and a **Turn** key simultaneously. This should only be attempted by the most gifted of Supox commanders, as it more often than not results in victory for your very happy opponent.

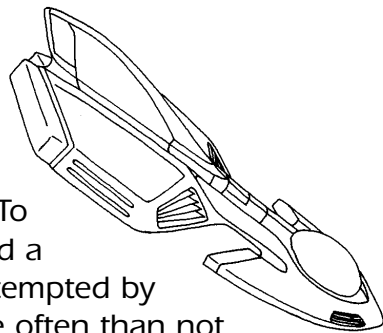

Pkunk Fury – Though small and holding few crew, the deft Pkunk Fury sports miraculous features. The Fury's main (and only) weapon is a rapid-fire, very short-range mini-gun that launches streams of dense, superheated metals forward and to the sides. This unusual weapon configuration allows the Fury to engage in certain non-traditional combat moves, such as running broadside. The popular Death Blossom attack is performed by flying adjacent to an enemy ship, and then simultaneously rotating and firing to create a beautiful spiral of destructive force.

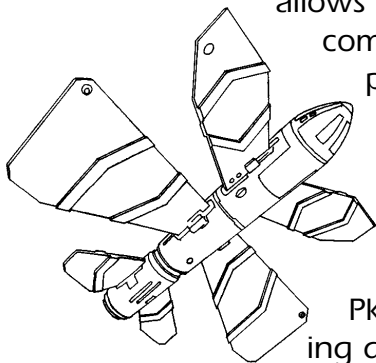

The vessel's energy is generated directly from the Pkunk captain's fierce mental emanations. By holding down the **Special** key, the player instructs the captain to radiate these psionic energies. Accompanying the regeneration are various insults and jibes spewed forth by the Pkunk captain toward his opponent.

When a Pkunk ship is destroyed in combat it will frequently reappear – instantly, and with no visible signs of damage. The Pkunk claim that this

resurrection is due to a trace of the blood of the gods, which flows through each Pkunk as the result of some divine indiscretion on their home world several thousand years ago. Other alien races believe that the “resurrected” vessels are in fact a mere projection generated by Pkunk vessels which are cloaked with some kind of invisibility field. To date, no one has explained why a “projection’s” weapons are genuinely destructive.

Melnorme Trader – The primary weapon aboard the Melnorme (pronounced Mehl-nor-may) Trader is a long-range, variable power blaster, fired by holding down the **Fire** key and then releasing it. The Melnorme’s projectile becomes larger and more destructive while the Fire key is held. The weapon has 4 degrees of power, reflected in the color of the pulsating missile. A green weapon is weakest, next comes blue, purple, and finally red. Each color change represents a doubling in the strength of the weapon. The Melnorme ship will not regenerate energy while “holding” the weapon; however, at these times the weapon acts as a front shield for the ship.

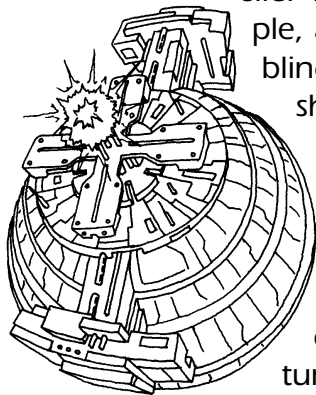

The special power of the Melnorme Trader is a long-range confusion ray which scrambles the enemy vessel control systems, causing the enemy to tumble out of control. The effect lasts only a few seconds, so the Melnorme must follow-up the attack with a powerful blaster strike, or an additional whack with another confusion ray. Note that in order to penetrate an enemy ship’s hardened control system, the Melnorme confusion weapon drains almost half of its maximum supply of energy.

Chmmr Avatar – The Chmmr Avatar may be the most powerful ship in space with a laser so dangerous that when fired, it ionizes the solar wind.

The laser strikes an enemy vessel's hull with twice the destructive force of the feared VUX laser.

Orbiting around the Avatar are three ZapSats – sturdy satellites that automatically fire their own laser weapons at incoming ships and missiles.

The Chmmr Avatar's special power is a tractor beam which generates a focused beam of artificial gravity, pulling in an enemy vessel like a fish on a line. The effect of the tractor depends on the size and speed of the opposing ship.

The biggest threat to the Avatar is the Kohr-Ah Marauder's fiery gas ring which will instantly destroy any satellites it touches.

Orz Nemesis – This menacing manta craft was built for combat! Atop the swift Nemesis is a rotating howitzer, which can pump out shells at a high rate of fire over medium range. Unlike vessels whose weapons are fixed forward, the Nemesis captain can swivel his gun fore, aft, port, starboard, or anywhere in-between. To swivel the gun, the player must hold down the **Special** key and then press the **Rotate** keys.

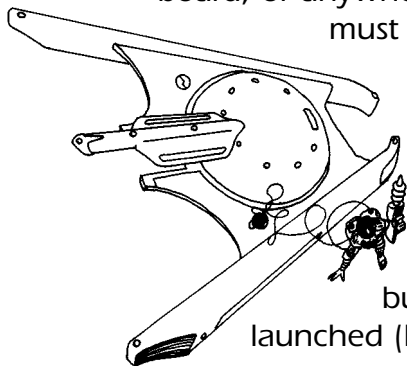

This ship's most exciting feature is its Space Marines! Encased in vacuum-fitted exo-skeletons, these relentless soldiers use their jet packs to chase down enemy ships, and then burn entry holes through their hulls. When launched (by pressing the Special key and the Fire key

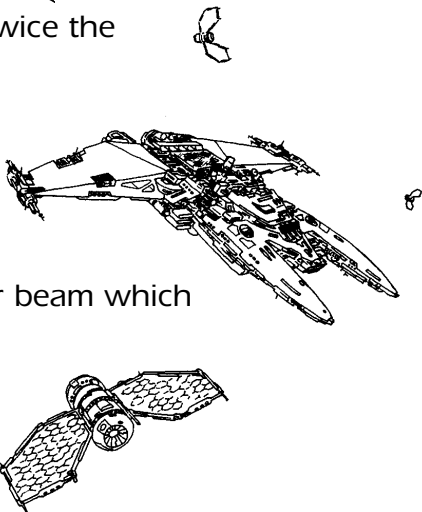

simultaneously), each departing Marine decreases the Nemesis' crew by one. Once inside the enemy ship, the Space Marines employ basic search-and-destroy tactics, wreaking havoc on the soft targets within. When an enemy ship is destroyed, any Marines onboard will jet out of the exploding hulk, and return to the Nemesis for more fuel and ammunition. Opponents would be wise to remember that Space Marines receive special training in using the Leyland Whip maneuver, and are exceptionally adept using a planet's gravity to speed them toward their target.

Druuge Mauler – This ship is perfect for sharp-shooters since its only weapon is a high-velocity, very long-range cannon. When fired, the recoil of the massive discharge will send the Mauler sailing backwards. Should the heavy projectile strike its target, the enemy vessel gets a similar shove. The experienced Druuge commander can use this recoil effect as a super-thruster. The Druuge Mauler has pitifully slow energy regeneration and when unable to shoot the ship is a sitting duck. To compensate for this weakness, the Druuge has a matter-to-energy converter that transforms crew members into instant bursts of power. Each time the special power is activated, one crew will be “tossed into the furnace.”

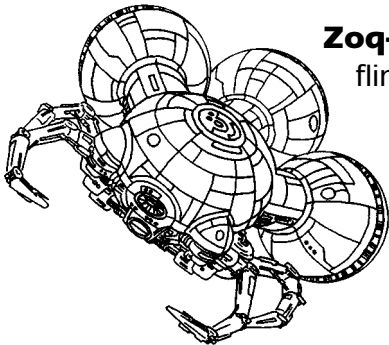
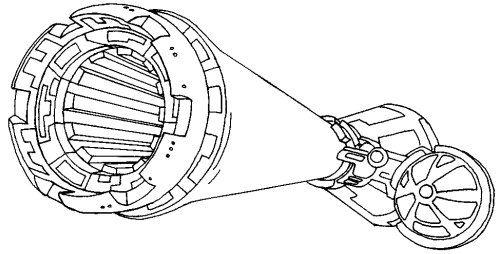

Zoq-Fot-Pik Stinger – The Zoq-Fot-Pik Stinger is a flimsy ship whose main weapon is a spray of minute anti-matter particles which annihilate a tiny portion of the enemy ship's hull, releasing colossal amounts of heat and light.

The Zoq-Fot-Pik's special power is a point-

blank range attack. Should the Stinger maneuver adjacent to an enemy vessel, it can quickly extend a rigid, alloy tube from the front of the ship, similar to an insect's proboscis. If the tube strikes the enemy ship's exterior, it bores a tiny hole through the hull metal and injects a high-pressure stream of hot plasma into the interior of the vessel.

Slylandro Probe – The Slylandro Probe tumbles through space devouring asteroids and zapping anything it can catch with massive electrical discharges. Like a shark, the Probe must continually move, constantly twisting its invisible magnetic scoops to scavenge interstellar hydrogen for its internal fusion generator. While the player cannot cause the Probe to stop, the rotational controls will cause a change in its trajectory, and the thrust control will make the Probe reverse direction instantly. Gravity has no effect on this vessel; however, impacting the planet will be severely damaging.

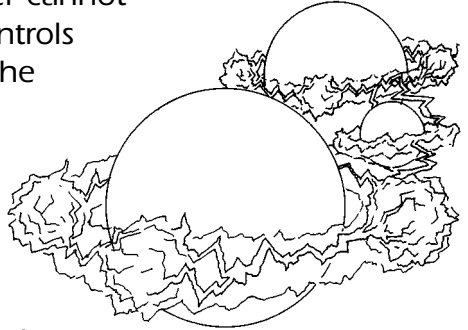

The Probe's best combat strategy is to first energize its lightning batteries by moving close to an asteroid and use its special power to pulverize the rock and absorb it as energy. Then the Probe must move toward its opponent, dodging all incoming missiles. When it has gotten close enough for the screen to zoom it to the most magnified view, the Probe should unleash its auto-fire lightning until its batteries are exhausted, all the while maneuvering to stay behind its opponent.

APPENDIX VI : FLAGSHIP MODULES

The Multi-Function Modules initially available at the Starbase are:

Planetary Lander Maximum: 10

This Module is actually a separate vehicle which you can launch from your flagship and send down to a planet surface. Although a planet lander appears to have been built to carry a crew of 2 Precursors, 12 human crew members can fit inside. You may wish to carry more than one lander, since you may lose a lander due to hostile conditions on alien planet surfaces.

Thruster Maximum: 11

Thrusters lock into place on your warp outrigger units, increasing your acceleration and maximum velocity and making travel through space less time-consuming. Fuel cost for HyperSpace travel remains constant, regardless of how many thrusters you have on board your vessel.

Turning Jets Maximum: 8

Turning Jets also fit in your outrigger units, but their function is to let your flag-ship turn more rapidly. Turning Jets are most important for rapid maneuvering in combat.

Crew Pod Maximum: 16

These modules provide living quarters and life-support for up to 50 additional crew members. When you purchase a Crew Pod, it will be empty. To fill it with new crew, visit the SHIPYARDS in the Earth Starbase.

Cargo Bay Maximum: 16

Cargo Bays hold up to 500 units of minerals or other cargo each. To see how much available cargo space your flagship possesses, use the CARGO command in the MANIFEST command menu. To remove a Cargo Bay, it must first be emptied, typically by visiting the Starbase Commander.

Fuel Tank Maximum: 16

Each Fuel Tank Module holds 50 units of fuel which is enough to take your flagship halfway across known space. Of course, if you are making a lot of planet landings, or are employing a powerful device, you may wish to increase your fuel capacity with more Tanks. Fuel Tanks are purchased empty, but can be filled from the Earth Starbase OUTFIT menu. You cannot remove a fuel tank module unless it is empty.

Dynamo Maximum: 16

Dynamos are finely engineered pieces of equipment whose function is to supply raw energy to your weapons systems by augmenting your normal combat batteries. A classic mistake in ship configuration is to load down a vessel with multiple weapons, but not include an appropriate number of Dynamos. The result is a ship whose firing rate is atrocious.

Ion-Gun Racks Maximum: 3 each

Ion-Gun Racks are poly-channel combat units which concentrate the raw energy of your ship's batteries and Dynamos into a focused destructive projectile. Depending on the exact placement of an Ion-Gun Rack or other weapon module, the ship will fire in one or more directions simultaneously. The most weapons you can have on your ship is four. The module slots in which you can put a weapon are marked in blue.

WEAPON POSITION

First (right most) slot
Second slot
Third slot
Last (left most) slot

FIRING EFFECT

Fires Forward
Fires a spread
Fires to both sides
Fires backwards

It is recommended that you balance the number of Ion-Gun Racks on your

vessel with 1/3 to 1/2 as many Dynamo Modules to provide your ship with an adequate rate of fire in combat.

Other Modules Maximum: Unknown

New types of Modules will become available at the Earth Starbase as the game progresses. The function and cost of such Modules will be explained as they are made available.

Game Credits

Programming
Game Design and Fiction
Additional Design

Fred Ford
Paul Reiche III
Greg Johnson, Fred Ford, Robert Leyland
and Greg Hammond

Art

George Barr, Paul Reiche III, Erol Otus,
Kyle Balda, Greg Johnson, and Armand
Cabrera

Sound Effects
Music

Paul Reiche III, Erol Otus, Fred Ford
Riku Nuottajarvi, Dan Nicholson, Marc
Brown, Aaron Grier, Eric Berge, Kevin
Palivec, Erol Otus and Tommy Dunbar

Producer
Assistant Producer

Pam Levins
Robert Daly

Testing

Tomi Quintana and Joel Dinolt

Manual

Paula Polley, Paul Reiche III and Dick
Moran

Manual Illustrations

Jeff Rianda and George Barr

Online Manual Adaptation

W.D. Robinson

Manual Updates

Harvey Bush, David Foster, Daniel Grove,
Josh Huynh, Ray Massa, W.D. Robinson,
Bobby Tait

90-DAY WARRANTY

Accolade, Inc. warrants for a period of 90 days from the date of purchase by the original purchaser of the Software that the recording medium on which it is recorded will be free from defects in materials and workmanship. Defective media which has not been subjected to misuse, excessive wear or damage due to carelessness may be returned during the 90-day period without charge.

After the 90-day period, defective media may be replaced in the United States for \$10 (U.S. dollars, plus 8.25% sales tax if the purchaser resides in California). Make checks payable to Accolade, Inc. and return to Accolade, Inc., Attn: Customer Service, 5300 Stevens Creek Blvd., Suite 500, San Jose, CA 95129. (To speed up processing, return only your CD-ROM. Please do not return collateral materials).

LICENSE AGREEMENT AND LEGAL MUMBO JUMBO

This computer software product (the "Software") and the user manual are provided to the Customer under license from Accolade, Inc., and are subject to the following terms and conditions, to which the Customer agrees by opening the package of the Software and user manual and/or using the Software. Granting of this license does not transfer any right, title or interest in the Software or the user manual to the Customer except as expressly set forth in this License Agreement.

Star Control II is a trademark of Accolade, Inc. Portions © 1992 Paul Reiche III & Fred Ford. Game © 1992 by Accolade, Inc. All rights are reserved. Neither the Software nor the user manual may be duplicated or copied for any reason. The customer may not transfer or resell the Software or user manual.

The remedies provided above are the Customer's sole and exclusive remedies. In no event shall Accolade, Inc. be liable for any direct, indirect, special, incidental or consequential damages with respect to the Software or the user manual. Except as provided above, Accolade, Inc. makes no warranties, either express or implied, with respect to the Software or the user manual, and expressly disclaims all implied warranties, including, without limitation, the warranty of merchantability and of fitness for a particular purpose.

All other trademarks and registered trademarks are properties of their respective owners.